

Schneider Electric

Energy and power meters catalogue
for Panel Builders



www.schneider-electric.com

Life Is On

Schneider
Electric

Schneider Electric

Energy and power meters catalogue for panel builders

Contents

Introduction	3
Selection guide panorama	4
Current transformers	7
Panel instruments	18
Basic energy metering IEM2000 series, IEM3000 series	29
Basic multi-function metering PM3000 series, PM5000 series	43
Communications and gateways Link150, Com'X 200, Com'X 210, Com'X 510	59
Commercial reference numbers See your Schneider Electric representative for complete ordering information.	76



www.schneider-electric.com

Clicking on a
Commercial Reference Number
or scanning the product's
QR Code
links you to further product information on
www.schneider-electric.com

Why Panel Builders Choose Schneider Electric?



Schneider Electric is the global specialist in energy management and as such it has the most complete power motoring product line, going from simple indicators (analogue meters) and CTs, to world class accurate energy meters and powerful compact power meters. These proven products come with multiple options to satisfy any requirement.

Schneider Electric products are safe and reliable. We comply with the most stringent standards, including IEC, MID, UL, etc., and we thoroughly test all products with third-party laboratories. This gives our partners the peace of mind and the confidence that they are maintaining a good reputation while delivering the best value in equipment and service to their customers.

Our products are simple to install, configure, and use. This saves our partners time and money and lets them deliver the best solutions in a timely and cost-effective manner.

Whatever the size or type of application, the PowerLogic™ product line is an integral part of smart panels.

Panorama of the PowerLogic range

Current transformers



Panel Instruments



CTs Ip/5 A	Name	iAMP	iVLT	AMP/VLT	iFRE	iCH/iCI
current transformer	Function	ammeter, voltmeter		ammeter, voltmeter	frequency meter	hour counter pulse counter
Installation <ul style="list-style-type: none"> insulated cable, diameter 21 to 35 mm, through transformer busbar through transformer cable connections 	Applications					
	Panel instrumentation					
	Panel instrumentation	I/U	I/U	I/U	F	hours/pulses
	Energy efficiency & cost					
	Sub-billing & cost allocation					
Demand & load management						
Billing analysis						
Power availability & reliability						
Compliance monitoring						
Sag/swell, transient						
Harmonics						
Revenue metering						
Revenue meter						

Characteristics

- transformation ratio: 40/5 A to 6000/5 A
- accuracy: class 0.5 to 3
- maximum rated operational voltage: 720 V AC
- tropicalised

Characteristics

Measurement accuracy	Class 1.5	± 0.5 % ± 1 digit	Class 1.5	± 0.5 % ± 1 digit	
Installation	DIN rail 4 x 18 mm modules	DIN rail 2 x 18 mm modules	flush mounted 72 x 72 mm 96 x 96 mm	DIN rail 2 x 18 mm modules	iCI, iCH: DIN rail 2 x 18 mm modules CH: flush mount
Measurement	iAMP: 30 A direct or external CT	iVLT: 600 V AC direct or external VT	VLT: 500 V AC direct or external VT AMP: external CT	400 V AC direct	
Communication ports					
Inputs / Outputs					
Memory capacity					

Panorama of the PowerLogic range (cont'd)

Basic energy metering



Basic multi-function metering



Name	iEM2000/ iEM2010/	iEM3000 Series	PM3000 Series	PM5000 Series
Function	kilowatt-hour meters	kilowatt-hour meters	metering & sub-metering Class 0.5S IEC 62053-22 Class 1 IEC 62053-21 Class 2 IEC 62053-23	metering & sub-metering Class 0.5S IEC 62053-22 Class 0.2S (PM55xx) IEC 62053-22 Class 1/2 IEC 62053-24

Applications

Panel instrumentation	E	I, U, F, P, Q, S, PF, E (Power demand and current demand)	I, U, F, P, Q, S, PF, E (Power demand and current demand)	I, U, F, P, Q, S, PF, E (Power demand and current demand)
-----------------------	---	--	--	--

Energy efficiency

Sub-billing & cost allocation				
Demand & load management				
Billing analysis				

Power availability & reliability

Compliance				
Dip/swell, transient				
Harmonics				

Revenue metering

Revenue meter				
---------------	--	--	--	--

Characteristics

Measurement accuracy	Class 0.5S / Class 1	Class 0.5S / Class 1	Class 0.5	Class 0.2S (PM55xx) Class 0.5S
Installation	DIN rail 1, 2, 5, or 7 x 18 mm modules	DIN rail	DIN rail	Flush mount 96 mm x 96 mm
Voltage measurement	400 V AC direct	50 V to 330 V (Ph-N) 80 V to 570 V (Ph-Ph) up to 1MV AC (ext VT)	50 V to 330 V AC (Ph-N) 80 V to 570 V AC (Ph-Ph) up to 1MV AC (ext VT)	20-400 V L-N 20-690 V L-L (PM55xx)
Current measurement	40 to 125 A direct or external CT	external CT	external CT	external CT
Communication ports		1	1	2
Inputs / Outputs		2 I/O	2 I/O	1DO for PM51xx 4/6 I/O PM53xx based on model
Memory capacity				256 kb

page 30

page 36

page 44

page 51

Link to:

[MORE](#)

[MORE](#)

[MORE](#)

[MORE](#)

Panorama of the PowerLogic range (cont'd)

Communications & gateways



Name	Link150	Com'X 210 Com'X 510
Function	Modbus Serial to Modbus TCP/IP protocol gateway	Modbus gateway plus Energy Server and Cloud connector

Features

RS-485 / Ethernet gateway	Ethernet Gateway	Ethernet Gateway
Devices supported	All Modbus devices	100+ known Schneider Electric devices and the ability to create custom Modbus models. EM3000 Series, iEM3000 Series, Acti9 Smartlink Masterpact, PM5000 Series, Compact NSX, iEM1, iEM2000 series, PM3000 Series, PM5350, PM5000, PM8000, ION7550/7650, CM4000
Web server with standard HTML pages	Configuration only	Com'X 510 - full support Com'X 210 - configuration only
Web server with custom HTML pages		Custom web page support
Real time data		Available on Com'X 510
Historical data		Com'X 510 onboard storage Com'X 210 - publish to database server
Automatic notification		Event Notification to FI
Alarm and event logs		
Waveform display		
Custom animated graphics		
Manual/automatic reports		

Characteristics

Ethernet ports Modbus TCP/IP protocol	2 (switch mode only)	2
RS-485 (2-wire / 4-wire) ports Modbus protocol	2w/4w - 1 (rj45)	1
Number of devices connected directly	32	64 devices/32 max Modbus, 2 analogue sensors
RS-232 configuration ports	1	
Miscellaneous	Serial line to Ethernet connectivity - serial or Ethernet master	Connectivity: WiFi, Ethernet, Zigbee, GPRS, + 3G
Installation	9 DIN rail	DIN rail

Link to:	page 62 MORE	page 66 MORE
-----------------	--	--

Current transformers

Schneider Electric is the global specialist in energy management and as such it has the most complete power motoring product line, going from simple indicators (analogue meters) and CTs, to world class accurate energy meters and powerful compact power meters. These proven products satisfy any requirement.

PB100316-35
056852NMD-2
056854NMD-2



METSECT5CC04



METSECT5MB025

Ip/5 A ratio

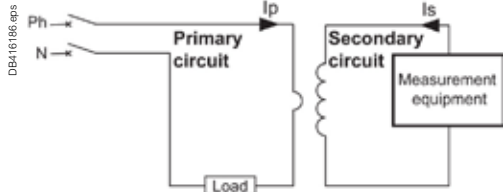

Application diagram of a CT.

The Ip/5 A ratio current transformer delivers at the secondary a current (I_s) of 0 to 5 A that is proportional to the current measured at the primary (I_p). This allows them to be used in combination with measurement equipment:

- Ammeters.
- Kilowatt-hour meters.
- Measurement units.
- Control relays.
- etc.

When the primary is energized, the measurement equipment nearly acts as a short circuit which keeps the secondary voltage very low. This voltage will increase significantly if the short circuit is removed.

CT selection - conductor rating aspects

The choice depends on the conductor profile and the maximum intensity of the primary circuit.

CT with let-through primary

Conductor type	Cable	Mixed, bars or cables	Vertical or horizontal bars	Vertical bars
Suggested Current Transformer and mounting				
Ratings (A)	40 to 250	150 to 800	200 to 4000	5000 to 6000
CT internal	Type C	Type M	Type D ⁽¹⁾	Type V

(1) Two secondary connectors (parallel internal wiring - only one secondary winding) for easier cable access. 1 lateral + 1 on one extremity. Warning: only one must be used at a time.

Specific mounting: use of cylinder

A cylindrical metallic spacer ensures a proper CT positioning when the conductor or the CT cannot be positioned perpendicular. Secured by bolt + nut.

CT with primary connection by screw and nut (example: use of cylinder with bar or cable)

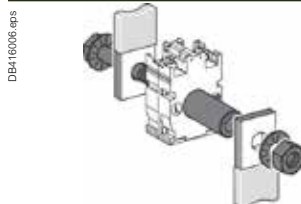

16550 (brass)

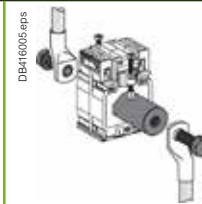

METSECT5CYL1 (aluminium)

See appropriate Installation Guide for these products.

CT selection - Electrical aspect Ip/5 A

- We recommend that you choose the ratio immediately higher than the maximum measured current (In).

Example:

In = 1103 A; ratio chosen = 1250/5.

- For small ratings:

from 40/5 to 75/5 and for an application with digital devices, we recommend that you choose a higher rating, for example 100/5.

This is because small ratings are less accurate and the 40 A measurement, for example, will be more accurate with a 100/5 CT than with a 40/5 CT.

- Specific case of the motor starter:

to measure motor starter current, you must choose a CT with primary current $I_p = I_d/2$ (I_d = motor starting current).

Validation of measurement solution according accuracy class

It consists in controlling the right adaptation of the CT on the accuracy class aspect. The accuracy class is specified in the project. The total dissipated power of the measurement circuit (meter + cables) should not be superior to the specified limit of the CT. This limit is for different standard classes. If necessary, the choice of the cable section, the CT or meter should be modify to fit the requirement.

Copper cable cross-section (mm ²)	Power per doubled meter at 20 °C (VA)	Schneider Electric device	Consumption of the current input (VA)
1	1	Ammeter 72 x 72 / 96 x 96	1.1
1.5	0.685	Analogue ammeter	1.1
2.5	0.41	Digital ammeter	0.3
4	0.254	PM8000	0.15
6	0.169	PM3000	0.3
10	0.0975		
16	0.062		

For each temperature variation per 10 °C bracket, the power drawn up by the cables increases by 4 %.

Application example

Project specification: **200 A**, in **Ø27** mm cable, accuracy class 1.

Our choice is **METSECT5MA020**.

For this CT selected on the chart (next page), the max acceptable power is **7 VA** (for "Accuracy class 1" which is specified in the project).

Internal profile type	Cables (mm)	Bars (mm)	Rating Ip/5 A (A)	Commercial reference number	Accuracy class		
					0.5	1	3
					Max. power (VA)		
MA							
	Ø27	10 x 32	150	METSECT5MA015	3	4	-
		15 x 25	200	METSECT5MA020	4	7	-
			250	METSECT5MA025	6	8	-
			300	METSECT5MA030	8	10	-
			400	METSECT5MA040	10	12	-

Control of the conformity of the measurement chain:

- PM3000 multi-meter: 0.3 VA.
- 4 meters of 2.5 mm², doubled wires: 0.41 x 4 = 1.64 VA.

Total: 0.3 + 1.64 = 1.94 VA (< 7 VA)

Conclusion: this CT is well adapted as the accuracy class will be even better than 1.

PB118085

Presentation of commercial reference numbers

MET SE CT **X** **XX** **XXX**

1 = 1 Amp
5 = 5 Amp
R = Rogowski

Last 3 digits = primary rating/10
2 letters = Form Factor

Examples:

METSECT5CC008 = 5 A secondary, Cables only, 75 A primary

METSECT5MC080 = 5 A secondary, mixed for cables and bars, 800 A primary

METSECTR30500 = Rogowski CT, 300 mm length, 96 mm diameter 50 A to 5000 A



METSECT5CC●●●

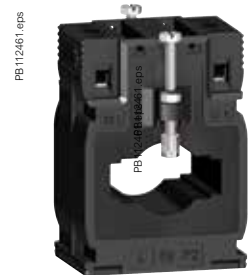

METSECT5MB●●●

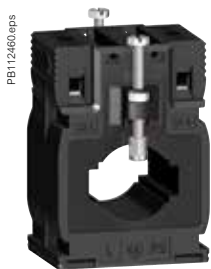

METSECT5MA●●●

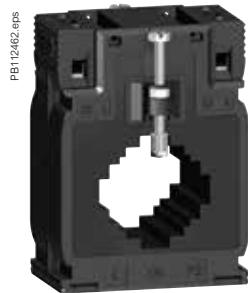

METSECT5MC●●●

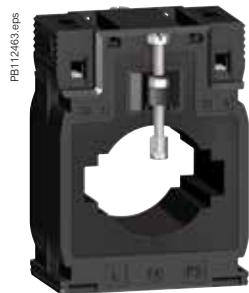

METSECT5MD●●●

Type C - current transformer (cable profile)				
Internal profile type	Cables (mm)	Bars (mm)	Rating Ip/5 A (A)	Commercial reference number
CC				
	Ø21	-	40	METSECT5CC004
			50	METSECT5CC005
			60	METSECT5CC006
			75	METSECT5CC008
			100	METSECT5CC010
			125	METSECT5CC013
			150	METSECT5CC015
			200	METSECT5CC020
250	METSECT5CC025			





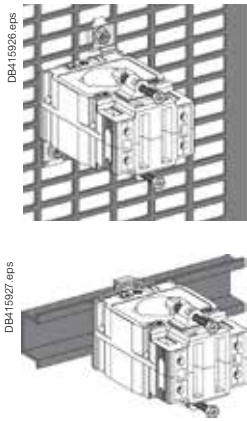

Type M - current transformers (mixed: cable/bar profile)				
MB				
	Ø26	12 x 40 15 x 32	250	METSECT5MB025
			300	METSECT5MB030
			400	METSECT5MB040
MA				
	Ø27	10 x 32 15 x 25	150	METSECT5MA015
			200	METSECT5MA020
			250	METSECT5MA025
			300	METSECT5MA030
			400	METSECT5MA040
MC				
	Ø32	10 x 40 20 x 32 25 x 25	250	METSECT5MC025
			300	METSECT5MC030
			400	METSECT5MC040
			500	METSECT5MC050
			600	METSECT5MC060
			800	METSECT5MC080
MD				
	Ø40	12 x 50 20 x 40	500	METSECT5MD050
			600	METSECT5MD060
			800	METSECT5MD080

See your Schneider Electric representative for complete ordering information.



Common characteristics	
Secondary current Is (A)	5 A
Maximum voltage rating Ue (V)	720 V
Frequency (Hz)	50/60 Hz
Safety factor (sf)	<ul style="list-style-type: none"> ■ 40 to 4000 A: sf ≤ 5 ■ 5000 to 6000 A: sf ≤ 10
Degree of protection	IP20
Operating temperature	<ul style="list-style-type: none"> ■ tropicalised range ■ -25 °C to +60 °C ⁽¹⁾ ■ relative humidity > 95 %
Compliance with standards	<ul style="list-style-type: none"> ■ IEC 61869-2 ■ VDE 0414
Secondary connection (as per model)	<ul style="list-style-type: none"> ■ by terminals for lug ■ by tunnel terminals ■ by screws

(1) Warning: some products are limited to +50 °C.

Type C - current transformer (cable profile)							
Internal profile type	Accuracy class			Overall dimensions (refer to drawing pages for details) W x H x D (mm)	Fastening mode	Accessories Cylinder 	
	0.5	1	3				
Max. power (VA)							
CC							
	-	-	1	44 x 66 x 37	<ul style="list-style-type: none"> ■ Adapter for DIN rails. ■ Mounting plate. 	16550 METSECT5CYL1	Included
	-	1.25	1.5				
	-	1.25	2				
	-	1.5	2.5				
	2	2.5	3.5				
	2.5	3.5	4				
	3	4	5				
	4	5.5	6				
	5	6	7				
MB							
	3	4	-	60 x 85 x 63	<ul style="list-style-type: none"> ■ Adapter for DIN rails. ■ Mounting plate. 	-	METSECT5COVER
	4	6	-				
	6	8	-				
MA							
	3	4	-	56 x 80 x 63	<ul style="list-style-type: none"> ■ Adapter for DIN rails. ■ Mounting plate. 	METSECT5CYL2	METSECT5COVER
	4	7	-				
	6	8	-				
	8	10	-				
	10	12	-				
MC							
	3	5	-	70 x 95 x 65	<ul style="list-style-type: none"> ■ Adapter for DIN rails. ■ Mounting plate. 	-	METSECT5COVER
	5	8	-				
	8	10	-				
	10	12	-				
	12	15	-				
	10	12	-				
MD							
	4	6	-	70 x 95 x 65	<ul style="list-style-type: none"> ■ Adapter for DIN rails. ■ Mounting plate. 	-	METSECT5COVER
	6	8	-				
	8	12	-				

See your Schneider Electric representative for complete ordering information.



METSECT5VV●●●

Type V current transformers (vertical bar profile)				
Internal profile type	Cables (mm)	Bars (mm)	Rating Ip/5 A (A)	Commercial reference number
VV				
	-	55 x 165	5000	METSECT5VV500 ★
			6000	METSECT5VV600 ★

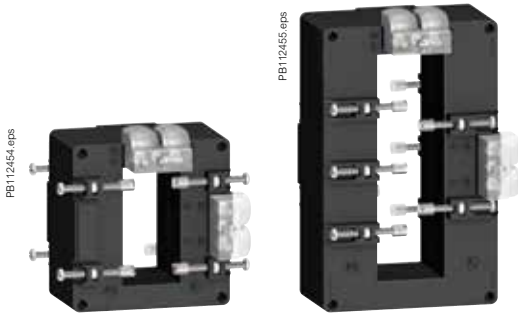

METSECT5DA●●●

METSECT5DB●●●

Type D - current transformers (vertical or horizontal bar - dual secondary terminals)				
DA				
	-	32 x 65	400	METSECT5DA040
			500	METSECT5DA050
			600	METSECT5DA060
			800	METSECT5DA080
			1000	METSECT5DA100
			1250	METSECT5DA125 ★
			1500	METSECT5DA150 ★
DB				
	-	38 x 127	1000	METSECT5DB100
			1250	METSECT5DB125 ★
			1500	METSECT5DB150 ★
			2000	METSECT5DB200 ★
			2500	METSECT5DB250 ★
			3000	METSECT5DB300 ★
DC				
	-	52 x 127	2000	METSECT5DC200 ★
			2500	METSECT5DC250 ★
			3000	METSECT5DC300 ★
			4000	METSECT5DC400 ★
DD				
	-	34 x 84	1000	METSECT5DD100
			1250	METSECT5DD125 ★
			1500	METSECT5DD150 ★
DE				
	-	54 x 102	1000	METSECT5DE100
			1250	METSECT5DE125 ★
			1500	METSECT5DE150 ★
			2000	METSECT5DE200 ★
DH				
	-	38 x 102	1250	METSECT5DH125 ★
			1500	METSECT5DH150 ★
			2000	METSECT5DH200 ★

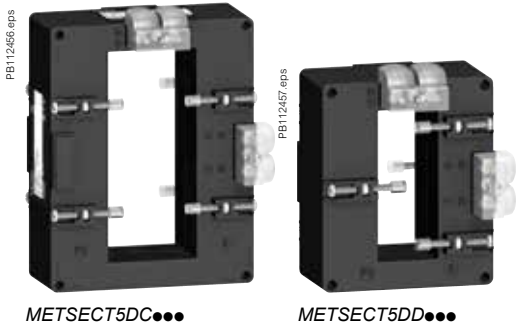

METSECT5DC●●●

METSECT5DD●●●

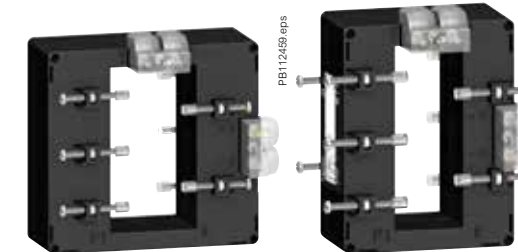

★ Operating temperature: -25 °C to 50 °C

See your Schneider Electric representative for complete ordering information.

Type V current transformers (vertical bar profile)							
Internal profile type	Accuracy class			Overall dimensions (refer to drawing pages for details) W x H x D (mm)	Fastening mode	Accessories	
	0.5	1	3			Cylinder	Sealable cover
	Max. power (VA)						
VV							
	60	-	-	175 x 273.5 x 110	■ Insulated locking screw.	-	Included
	70	-	-				

Type D - current transformers (vertical or horizontal bar - dual secondary terminals)							
DA							
	4	8	-	90 x 94 x 90	■ Insulated locking screw.	-	Included
	8	10	-				
	8	12	-				
	12	15	-				
	15	20	-				
	15	20	-				
	20	25	-				
DB							
	6	10	-	99 x 160 x 87	■ Insulated locking screw.	-	Included
	8	12	-				
	10	15	-				
	15	20	-				
	20	25	-				
	25	30	-				
DC							
	25	30	-	125 x 160 x 87	■ Insulated locking screw.	-	Included
	30	50	-				
	30	50	-				
	30	50	-				
DD							
	10	15	-	96 x 116 x 87	■ Insulated locking screw.	-	Included
	12	15	-				
	15	20	-				
DE							
	12	15	-	135 x 129 x 85	■ Insulated locking screw.	-	Included
	15	20	-				
	20	25	-				
	20	25	-				
DH							
	12	15	-	98 x 129 x 75	■ Insulated locking screw.	-	Included
	12	15	-				
	20	25	-				

★ Operating temperature: -25 °C to 50 °C

See your Schneider Electric representative for complete ordering information.

CT current transformers dimensions

CC internal profile type

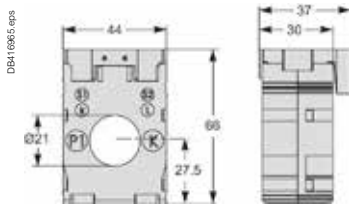

MB internal profile type

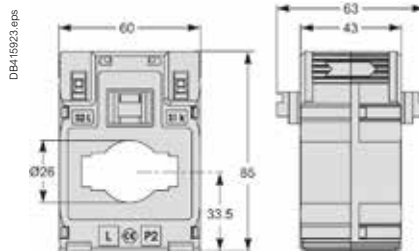

MA internal profile type

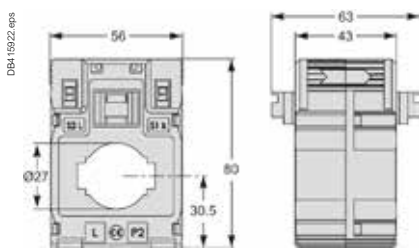

MC internal profile type

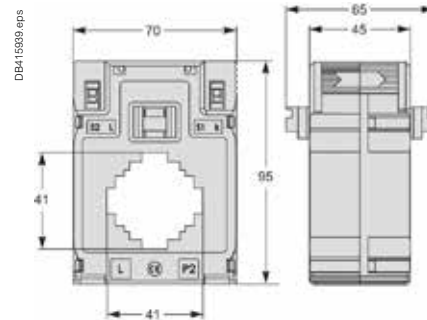

MD internal profile type

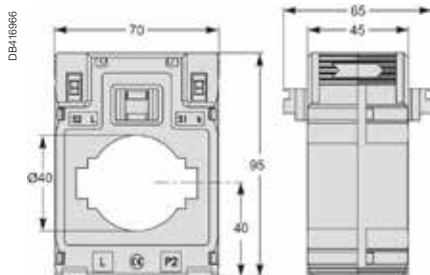

DA internal profile type

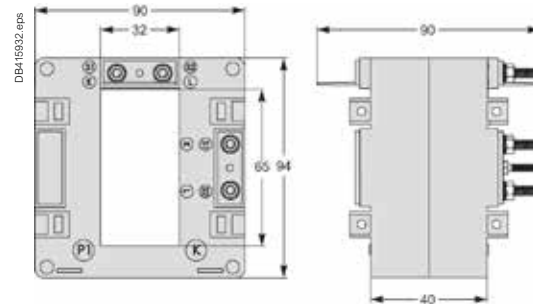

DB internal profile type

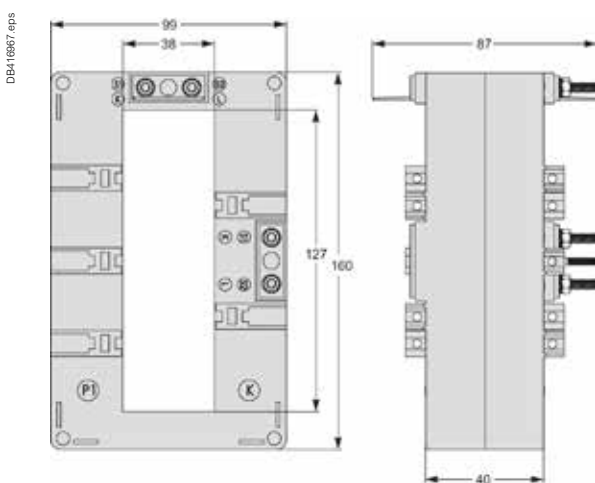

DC internal profile type

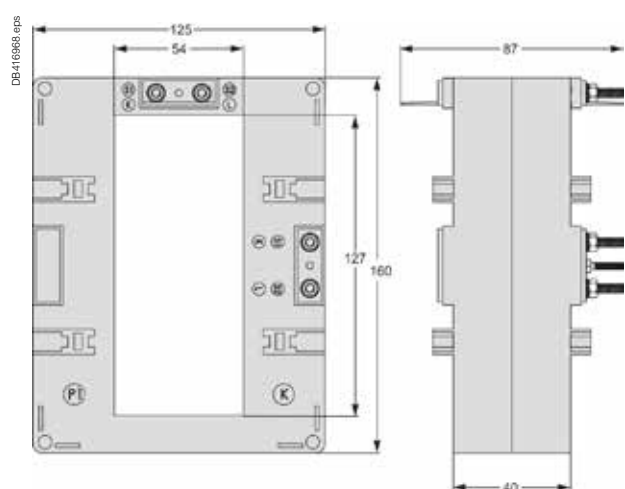

See appropriate Installation Guide for these products.

DD internal profile type

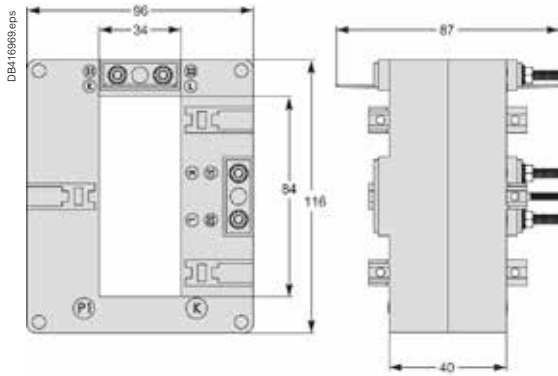

DE internal profile type

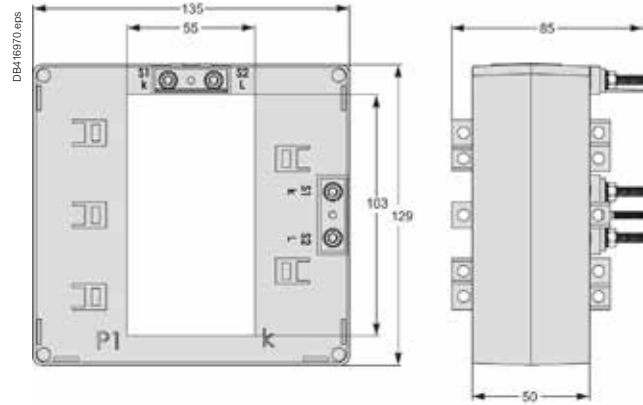

DH internal profile type

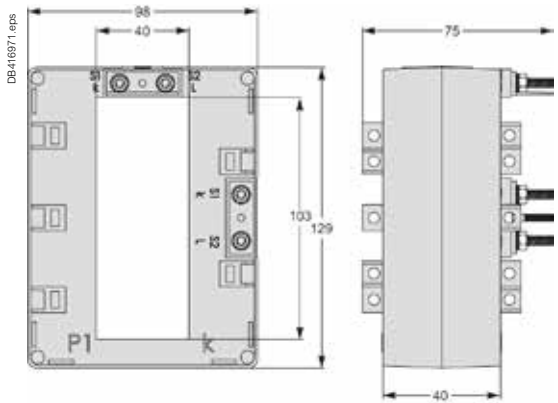

VV internal profile type

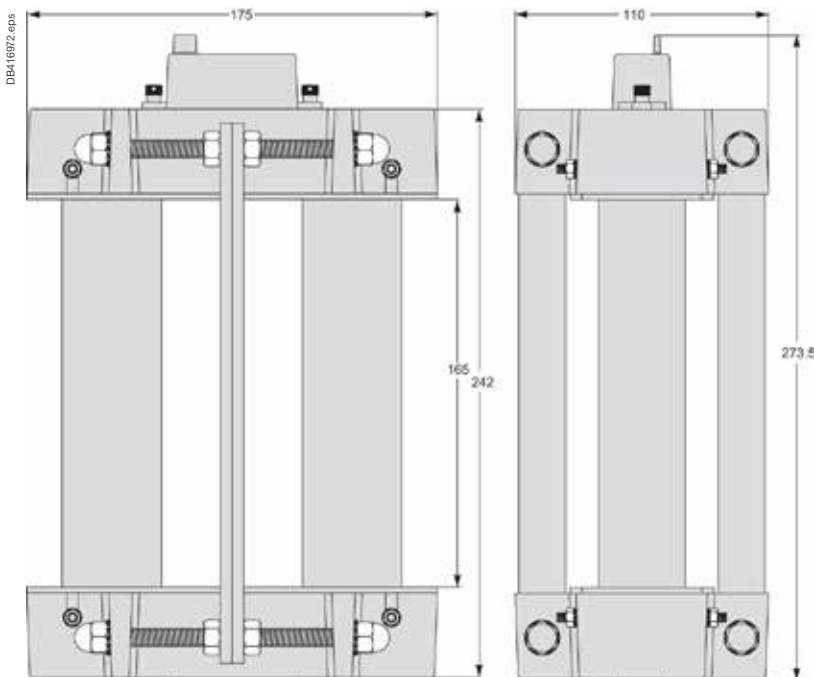

See appropriate Installation Guide for these products.

Cylinders dimensions

METSECT5CYL1



Aluminium

METSECT5CYL2



Aluminium

16550

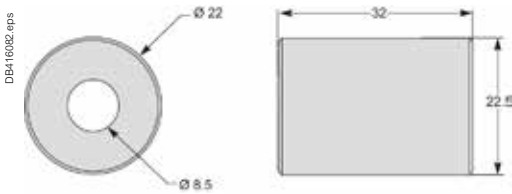

Brass

16551

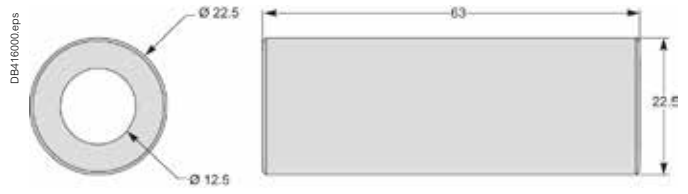

Brass

Covers

METSECT5COVER

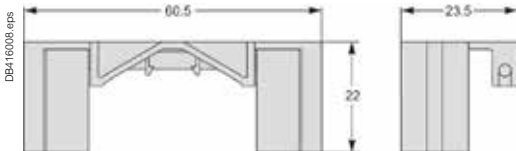

See appropriate Installation Guide for these products.

PB118060



METSECTR25500

PowerLogic Rogowski Current Transformer A - d = 80 mm lead = 2.4m

Main	METSECTR25500	METSECTR30500	METSECTR46500	METSECTR60500	METSECTR90500
Range	PowerLogic				
Product or component type	Current transducer				
Accessory / part category	Measurement accessory				
Range compatibility	PowerLogic EM3500 EM3555A EM3502A EM3560 EM3550A EM3560 EM3561A PowerLogic EM4200 EM4236 EM4235 Acti9 iEM3000 iEM3555 iEM3565				
Current transformer type	Flexible core				
Complementary					
Electrical connection	Flying lead 2.4 m 600 V				
Cable	1000 V AC UL style 21223 cable with 22 AWG leads				
[In] rated current	50 A to 5000 A				
Network frequency	50 Hz				
Frequency measurement range	50 Hz to 1.5 kHz				
Measurement accuracy	±1 % from 50 A to 5000 A				
Installation category	600 V Cat IV				
Pollution degree	2				
Dimensions	METSECTR25500	METSECTR30500	METSECTR46500	METSECTR60500	METSECTR90500
Width	8 mm diameter	8 mm diameter	8 mm diameter	8 mm diameter	8 mm diameter
Height	250 mm CT core length	300 mm CT core length	460 mm CT core length	600 mm CT core length	900 mm CT core length
Diameter	80 mm	96 mm	146 mm	191 mm	287 mm
Environment					
Standards	ANSI/IEEE C57.13				
Product certifications	CURus UL recognized				
Ambient air temperature for operation	-15 °C to 60 °C				
Ambient air temperature for storage	-40 °C to 70 °C				
Commercial Reference Numbers					
METSECTR25500	Powerlogic - Rogowski current transformer, 250 mm CT core length, 80 mm diameter				
METSECTR30500	Powerlogic - Rogowski current transformer, 300 mm CT core length, 96 mm diameter				
METSECTR46500	Powerlogic - Rogowski current transformer, 460 mm CT core length, 146 mm diameter				
METSECTR60500	Powerlogic - Rogowski current transformer, 600 mm CT core length, 191 mm diameter				
METSECTR90500	Powerlogic - Rogowski current transformer, 900 mm CT core length, 287 mm diameter				

Panel instruments

Schneider Electric panel instruments are safe and reliable. We comply with the most stringent standards, including IEC, MID, UL, etc., and we thoroughly test all products with third-party laboratories.

Our products are simple to install, configure, and use. This saves our partners time and money and lets them deliver the best solutions in a timely and cost-effective manner. Whatever the size or type of application, the PowerLogic™ product line is an integral part of smart panels.

DB118006

PB112024

PB101116



16029



15202



16003



iAMP.



iVLT.

Function

iAMP

Ammeters measure the current flowing through an electric circuit in amps.

iVLT

Voltmeters measure the potential (voltage) difference of an electric circuit in volts.

Common technical data

- Accuracy: class 1.5.
- Complies with standards IEC 60051-1, IEC 61010-1 and IEC 61000-4.
- Ferromagnetic device.
- Pseudo-linear scale over 90°.
- Ammeters (except catalogue number 16029):
 - connection on CT, ratio In/5, to be ordered separately interchangeable dials.
- Temperature:
 - operating temperature: -25 °C to 55 °C
 - reference temperature: 23 °C
- Influence of temperature on accuracy: ±0.03 %/°C.
- Utilisation frequency: 50 Hz to 60 Hz.
- Consumption:
 - AMP: 1.1 VA
 - VLT catalogue number 15060: 2.5 VA
 - VLT catalogue number 16061: 3.5 VA.
- Permanent overload:
 - AMP: 1.2 In
 - VLT: 1.2 Un.
- Maximum overload for 5 s:
 - AMP: 10 In
 - VLT: 2 Un.
- Connection: tunnel terminals for 1.5 to 6 mm² rigid cables.

Commercial reference numbers

Type	Scale	Connection with CT	Width in mod. of 9 mm	Comm. ref. no.
iAMP with direct connection				
	0-30 A	no	8	16029
iAMP with connection on CT				
Basic device (delivered without dial)		X/5	8	16030
Dial	0-5 A			16031
	0-50 A	50/5		16032
	0-75 A	75/5		16033
	0-100 A	100/5		16034
	0-150 A	150/5		16035
	0-200 A	200/5		16036
	0-250 A	250/5		16037
	0-300 A	300/5		16038
	0-400 A	400/5		16039
	0-500 A	500/5		16040
	0-600 A	600/5		16041
	0-800 A	800/5		16042
	0-1000 A	1000/5		16043
	0-1500 A	1500/5		16044
	0-2000 A	2000/5		16045
iVLT				
	0-300 V		8	16060
	0-500 V		8	16061

See your Schneider Electric representative for complete ordering information.

PB112024



15202

iAMP.

PB112023



15201

iVLT.

PB112025



15208

iFRE.

Function

iAMP

Ammeters measure in amps the current flowing through an electric circuit.

iVLT

Voltmeters measure in volts the potential (voltage) difference of an electric circuit.

iFRE

The frequency meter measures in hertz the frequency of an electric circuit from 20 to 600 V AC.

Common technical data

- Supply voltage: 230 V.
- Operating frequency: 50 Hz to 60 Hz.
- Display by red LED: 3 digits, h = 8 mm (0.31 in).
- Accuracy at full-scale : 0.5 % ±1 digit.
- Consumption: max. 5 VA or rated 2.5 VA.
- Degree of protection:
 - IP40 on front face.
 - IP20 at terminal level.
- Connection: tunnel terminals for 2.5 mm² cables.

Specific data

10 A direct reading ammeter

- Minimum value measured: 4 % of rating.
- Measurement input consumption: 1 VA.

Multi-rating ammeter

- Ratings:
 - in direct reading: 5 A.
 - by CT (not supplied) configurable on the front face of the ammeter: 10, 15, 20, 25, 40, 50, 60, 100, 150, 200, 250, 400, 500, 600, 800, 1000, 1500, 2000, 2500, 4000, 5000 A.
- Minimum value measured: 4 % of rating.
- Measurement input consumption: 0.55 VA.

Voltmeter

- Direct measurement: 0...600 V.
- Input impedance: 2 MW.
- Minimum value measured: 4 % of rating.

Frequency meter

- Minimum value measured: 20 Hz.
- Maximum value measured: 100 Hz.
- Full-scale display: 99.9 Hz.

Compliance with standards

- Safety: IEC/EN 61010-1.
- EMC electromagnetic compatibility: IEC/EN 65081-1 and IEC/EN 65082-2.

Commercial reference numbers

Type	Scale	Connection with CT	Width in mod. of 9 mm	Comm. ref. no.
Direct reading iAMP	0-10 A	No	4	15202
	0-5000 A	As per rating	4	15209
iVLT	0-600 V		4	15201
	20-100 Hz		4	15208

See your Schneider Electric representative for complete ordering information.



PB101116-30_C

AMP for standard feeder.



16009

Function

The 72 x 72 measurement devices are designed for flush-mounted installation on doors, wicket doors and front plates of enclosures and cubicles.

AMP

The ammeters measure in amps the current flowing through an electrical circuit.

VLT

The voltmeter measure in volts the potential difference (voltage) of an electrical circuit.



PB101119-30_C

AMP for motor feeder.



16006



PB101116-30_C

VLT.



16005

Common technical data

- Accuracy: class 1.5.
- Compliance with standard IEC 60051-1, IEC 61010-1 and IEC 61000-4.
- Ferromagnetic device.
- Scale length: 62 mm over 90°.
- Mounting in enclosure or in cubicle.
- Degree of protection: IP52.
- Maximum operating position: 30° / vertical.
- Temperature:
 - operation: -25 °C to 50 °C.
 - reference: 23 °C.
- Influence of temperature on accuracy: ±0.003 %/ °C.
- Utilisation frequency: 50 Hz to 60 Hz.

AMP specific technical data

- Needs a In/5 CT to be ordered separately.
- Interchangeable dials to be ordered separately.
- Consumption: 1.1 VA.
- Permanent overload: 1.2 In.
- Maximum overload for 5 s: 10 In.

VLT specific technical data

- Consumption: 3 VA.
- Permanent overload: 1.2 Un.
- Maximum overload for 5 s: 2 Un.

Commercial reference numbers

Type	Scale	Connection on CT	Comm. ref. no.
AMP for standard feeder			
Basic device (delivered without dial)		X/5	16004
1.3 In dial	0-50 A	50/5	16009
	0-100 A	100/5	16010
	0-200 A	200/5	16011
	0-400 A	400/5	16012
	0-600 A	600/5	16013
	0-1000 A	1000/5	16014
	0-1250 A	1250/5	16015
	0-1500 A	1500/5	16016
	0-2000 A	2000/5	16019
AMP for motor feeder			
Basic device (delivered without dial)		X/5	16003
3 In dial	0-30-90 A	30/5	16006
	0-75-225 A	75/5	16007
	0-200-600 A	200/5	16008
VLT			
	0-500 V		16005

See your Schneider Electric representative for complete ordering information.



AMP for standard feeder.



16079



AMP for motor feeder.



16076



VLT.



16075

Function

The 96 x 96 measurement devices are designed for flush-mounted installation on doors, wicket doors and front plates of enclosures and cubicles.

AMP

The ammeters measure in amps the current flowing through an electrical circuit.

VLT

The voltmeter measure in volts the potential difference (voltage) of an electrical circuit.

Common technical data

- Accuracy: class 1.5.
- Compliance with standard IEC 60051-1, IEC 61010-1 and IEC 61000-4.
- Ferromagnetic device.
- Scale length: 80 mm over 90°.
- Mounting in enclosure or in cubicle.
- Degree of protection: IP52.
- Maximum operating position: 30° / vertical.
- Temperature:
 - operation: -25 °C to 50 °C.
 - reference: 23 °C.
- Influence of temperature on accuracy: ±0.003 % / °C.
- Utilisation frequency: 50 Hz to 60 Hz.

AMP specific technical data

- Needs a In/5 CT to be ordered separately.
- Interchangeable dials to be ordered separately.
- Consumption: 1.1 VA.
- Permanent overload: 1.2 In.
- Maximum overload for 5S: 10 In.

VLT specific technical data

- Consumption: 3 VA.
- Permanent overload: 1.2 Un.
- Maximum overload for 5S: 2 Un.

Commercial reference numbers

Type	Scale	Connection on CT	Comm. ref. no.
AMP for standard feeder			
Basic device (delivered without dial)		X/5	16074
1.3 In dial	0-50 A	50/5	16079
	0-100 A	100/5	16080
	0-200 A	200/5	16081
	0-400 A	400/5	16082
	0-600 A	600/5	16083
	0-1000 A	1000/5	16084
	0-1250 A	1250/5	16085
	0-1500 A	1500/5	16086
	0-2000 A	2000/5	16087
	0-2500 A	2500/5	16088
	0-3000 A	3000/5	16089
	0-4000 A	4000/5	16090
	0-5000 A	5000/5	16091
0-6000 A	6000/5	16092	
AMP for motor feeder			
Basic device (delivered without dial)		X/5	16073
3 In dial	0-30-90 A	30/5	16076
	0-75-225 A	75/5	16077
	0-200-600 A	200/5	16078
VLT			
	0-500 V		16075

See your Schneider Electric representative for complete ordering information.

Function

The 48 x 48 selector switches are designed for flush-mounted installation on doors, wicket doors and front plates of enclosures and cubicles.

CMA

The ammeter selector switch uses a single ammeter (by means of current transformers) for successive measurement of the currents of a three-phase circuit.

CMV

The voltmeter selector switch uses a single voltmeter for successive measurement of the voltages (phase-to-phase and phase-to-neutral) of a three-phase circuit.

Common technical data

- Durability:
 - electrical: 100,000 operations.
 - mechanical: 2,000,000 operations.
- AgNi contact.
- Operating temperature: -25 °C to 50 °C.
- Compliance with standards IEC/EN 60947-3.
- Degree of protection:
 - IP65 on front face.
 - IP20 at terminal level.

Commercial reference numbers

Type	Rating (A)	Voltage (V)	Number of positions	Comm. ref. no.
CMA	20		4	16017
CMV		500	7	16018

See your Schneider Electric representative for complete ordering information.

Connection

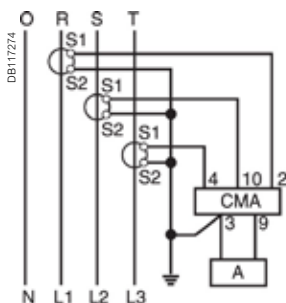

CMA.

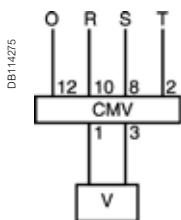
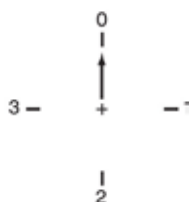

CMV.

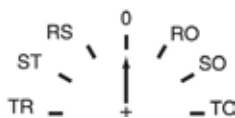

Reading 3 phase-to-earth voltages + 3 phase-to-phase voltages.

Note: when connecting do not remove the pre-cabling.

See appropriate Installation Guide for this product.



iCMA.



iCMV.

Function

iCMA

This 4-position ammeter selector switch uses a single ammeter (using current transformers) for successive measurement of the currents of a three-phase circuit.

iCMV

This 7-position voltmeter selector switch uses a single voltmeter for successive measurement of voltages (phase-to-phase and phase-to-neutral) of a three-phase circuit.

Common technical data

- Rotary handle.
- Maximum operating voltage: 440 V, 50/60 Hz.
- Nominal thermal current: 10 A.
- Operating temperature: -20 °C to 55 °C.
- Storage temperature: -25°C to 80°C.
- Mechanical durability (AC21A-3 x 440 V): 2,000,000 operations.
- Degree of protection:
 - IP66 on front face.
 - IP20 at terminal level.
- Electrical durability: 1,000,000 operations.
- Connection: jumper terminals with captive screws, for cables up to 1.5 mm².
- Complies with standards: IEC/EN 60947-3.

Commercial reference numbers

Type	Rating (A)	Voltage (V AC)	Width in mod. of 9 mm	Comm. ref. no.
iCMA	10	415	4	15126
iCMV	10	415	4	15125

See your Schneider Electric representative for complete ordering information.

Connection

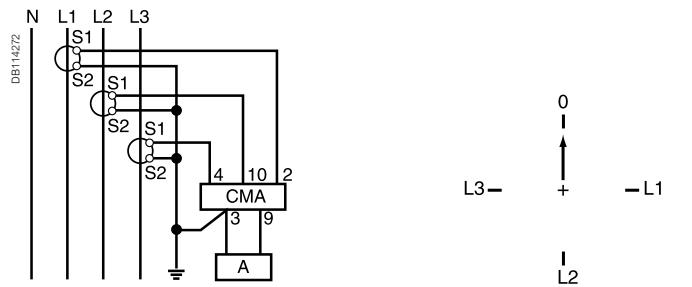

iCMA.



iCMV.

See appropriate Installation Guide for this product.

PB112026



15440

iCH "DIN".

DB119003



15607

CH "48 x 48".

Function

Electromechanical counter that counts the operating hours of a machine or piece of electrical equipment. Giving a precise indication of operating time, the counter is used to decide when to carry out preventive maintenance.

Common technical data

- Electromechanical display.
- Maximum display: 99999.99 hours.
- Display accuracy: 0.01 %.
- Without reset.
- Storage temperature: -25 °C to 85 °C.
- Connection: tunnel terminals for 2.5 mm² cable.

Specific technical data

iCH "DIN"

- Consumption: 0.15 VA.
- Operating temperature: -10 °C to 70 °C.
- Mounting on DIN rail.

CH "48 x 48"

- Consumption:
 - 15607: 0.25 VA
 - 15608: 0.15 VA
 - 15609: 0.02 VA to 12 V and 0.3 VA to 36 V.
- Operating temperature: -20 °C to 70 °C.
- Degree of protection: IP65 on front face.
- Mounting on front face of monitoring switchboards.

Commercial reference numbers

Type	Voltage (V)	Width in mod. of 9 mm	Comm. ref. no.
iCH "DIN"	230 V AC ± 10 %/50 Hz	4	15440
CH "48 x 48"	24 V AC ± 10 %/50 Hz		15607
	230 V AC ± 10 %/50 Hz		15608
	12 to 36 V DC		15609

See your Schneider Electric representative for complete ordering information.

Connection

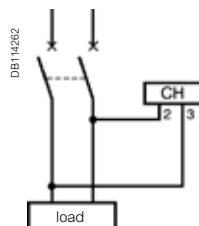

iCH "DIN".

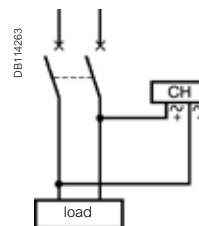

CH "48 x 48".

See appropriate Installation Guide for this product.



iCI impulse counter

Function

Electromechanical counter designed to count impulses emitted by: kilowatt-hour meters, temperature overrun detectors, people meters, speed meters, etc.

Common technical data

- Supply and metering voltage: 230 V AC \pm 10 %, 50/60 Hz.
- Consumption: 0.15 VA.
- Maximum display: 9 999 999 impulses.
- Without reset.
- Metering data:
 - minimum impulse time: 50 ms
 - minimum time between 2 impulses: 50 ms.
- Storage temperature: -25 °C to 85 °C.
- Operating temperature: -10 °C to 70 °C.
- Connection: tunnel terminals for 2.5 mm² cable.

Commercial reference numbers

Type	Width in mod. of 9 mm	Comm. ref. no.
iCI	4	15443

Connection

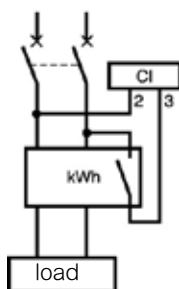
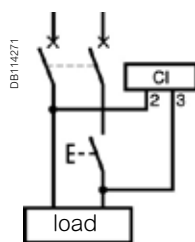

See appropriate *Installation Guide* for this product.

Analogue ammeters and voltmeters iAMP, iVLT

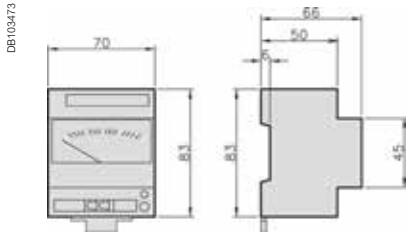

Digital ammeters, voltmeter and frequency meter iAMP, iVLT

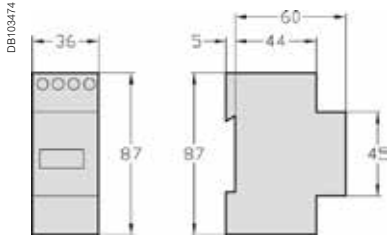

iCMA and iCMV selector switches

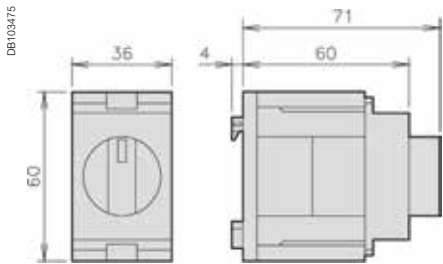

72 x 72 analogue ammeters and voltmeter

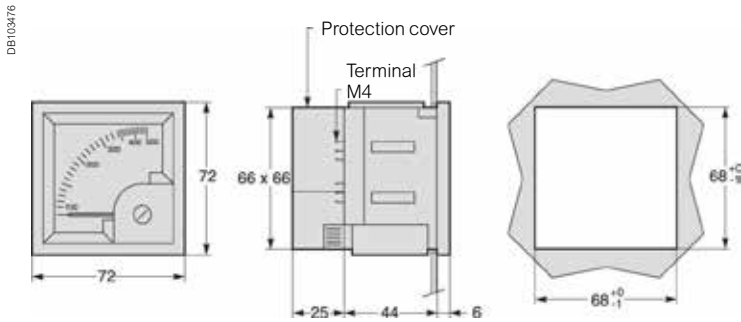

96 x 96 analogue ammeters and voltmeter

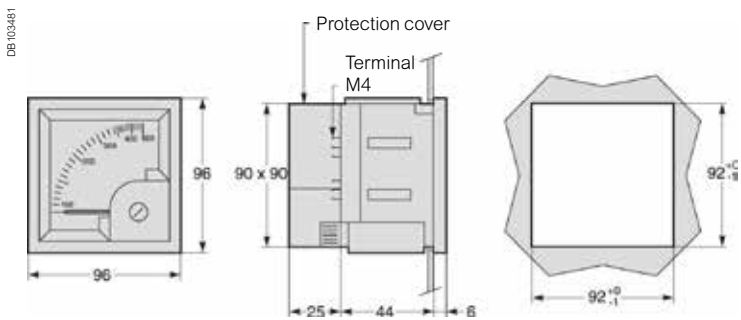

See the appropriate Installation Guide for this product.

48 x 48 CMA and CMV selector switches

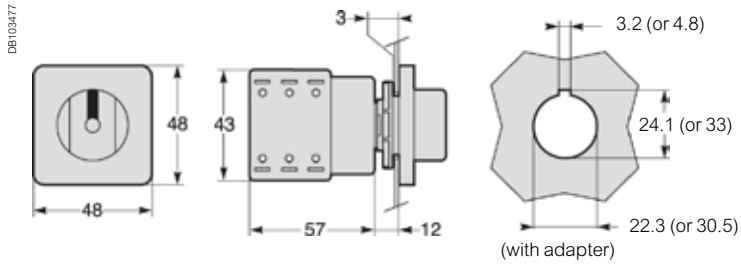

iCI impulse counter and iCH hour counter

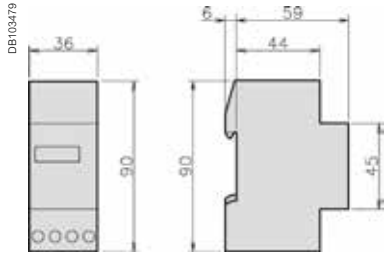

48 x 48 CH hour counters

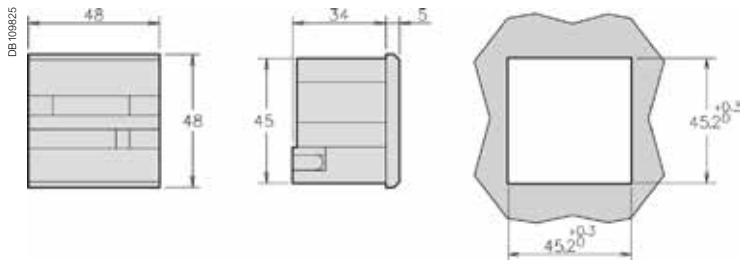

See the appropriate *Installation Guide* for this product.

Basic energy metering

Whether you require a single-phase kWh meters or full-featured, dual tariff energy meter, Schneider Electric provides iEM2xxx & iEM3xxx series meters to best fit your customer's application.

- PowerLogic iEM2000 series
- PowerLogic iEM2100 series
- PowerLogic iEM3000 series

PB108410
PB115001
PB108401



A9MEM2000



A9MEM2100



A9MEM3100

Acti9 iEM2000 Series

The Acti9 iEM2000 series energy meters offer a cost-attractive, competitive range of single-phase DIN rail-mounted energy meters ideal for sub-billing and cost allocation applications.

Applications

- Monitor the power consumption of each sector, unit, workshop, etc.
- Manage an electrical installation and optimise your building's power efficiency
- Various business, industrial and residential applications



A9MEM2000

The solution for

All markets that can benefit from a solution that includes PowerLogic iEM2000 series meters:

- Buildings
- Industry
- Data Centre & networks
- Infrastructures (airport, road tunnels, telecom).

Benefits

The Acti9 iEM2000 series meters are economical and easy to install in all switchboards up to 10 kVA.

Competitive advantages

- MID compliant (selected models) providing certified accuracy and data security
- Compact size
- A complete range of energy meters
- Compatible with Acti9 range

Energy management system:

To get the most effective use from your Schneider Electric measurement and metering devices, we offer a range of dedicated data loggers and gateways for your building energy management.

Conformity of standards

- IEC 62053-21
- IEC 61557-12
- EN 50470-3

iEM2000 feature selection

	iEM2000T	iEM2000	iEM2010
Self-powered	■	■	■
Display		■	■
Width (mm)	18	18	18
Current input	40 A	40 A	40 A
Active Energy accuracy	Class 1	Class 1	Class 1
Digital outputs	1 P/O		1 P/O
MID for billing application		■	■
Commercial reference number	A9MEM2000T	A9MEM2000	A9MEM2010

See your Schneider Electric representative for complete ordering information.

iEM2000 series technical specifications

Technical specifications

	iEM2000T	iEM2000	iEM2010
Direct connection	40 A	40 A	40 A
Pulse output operation	100 pulses/kwh (120ms long)		
Display capacity	999999.9KWh		
Voltage range (L-N)	184 to 276 V AC		
Operating frequency	50/60 Hz		
Meter constant LED	3200 flashes per KWh		
Wiring capacity (Top)	4 mm ²		
Wiring capacity (Bottom)	10 mm ²		
Consumption	<10 VA		
IP protection	IP40 front panel and IP20 casing		
Temperature	-10°C to 55°C		
Active energy	■	■	■
Reactive energy			
Active power			
Reactive power			
Power Factor			
Current and voltage			
Frequency			

iEM2000 dimensions

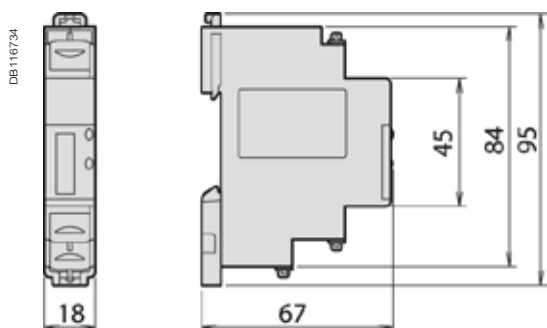

See the appropriate product Installation Guide for complete instructions.

Acti9 iEM2100 Series

The Acti9 iEM2100 series energy meters are ideal for basic kWh metering and billing applications and support two protocols (Modbus and M-bus) that allow them to integrate seamlessly into your customers' existing networks.

Applications

- Monitor the power consumption of each sector, unit, workshop...
- Manage an electrical installation and optimise your building's power efficiency
- Various business, industrial and residential applications

PB118959



A9MEM2100

The solution for

All markets that can benefit from a solution that includes PowerLogic iEM2100 series meters:

- Buildings
- Industry
- Data Centre & networks
- Infrastructures (airport, road tunnels, telecom).

Benefits

The Acti9 iME kilowatt-hour meters are specially economic and easy to install in all switchboards.

Competitive advantages

- Compact size
- MID compliant (selected models) providing certified accuracy and data security
- Four quadrant measurement
- Electrical parameter measurement eg. V, I, P, PF
- Onboard Modbus or M-bus communication
- A complete range of energy meters
- Compatible with Acti9 range

Energy management system:

To get the most effective use from your Schneider Electric measurement and metering devices, we offer a range of dedicated data loggers and gateways for your building energy management.

Conformity of standards

- IEC 62052-11
- IEC 62053-21
- IEC 62053-23
- EN 50470-1
- EN 50470-3

iEM2100 feature selection

	iEM2100	iEM2105	iEM2110	iEM2135	iEM2150	iEM2155
Self-powered	■	■	■	■	■	■
Display	■	■	■	■	■	■
Width (mm)	36	36	36	36	36	36
Current input	63 A	63 A	63 A	63 A	63 A	63 A
Active Energy accuracy	Class 1	Class 1	Class 1	Class 1	Class 1	Class 1
Reactive Energy accuracy	Class 2	Class 2	Class 2	Class 2	Class 2	Class 2
Four quadrant Energy measurement			■	■	■	■
Multi-tariff			2	2		2
Digital inputs			1 (tariff switching)			
Digital outputs		1 P/O	2 P/O's			
Communication protocol				M-bus	Modbus RS-485	Modbus RS-485
MID for billing application			■	■		■
Commercial reference number	A9MEM2100	A9MEM2105	A9MEM2110	A9MEM2135	A9MEM2150	A9MEM2155

See your Schneider Electric representative for complete ordering information.

Acti9 iEM2100 series technical specifications

Technical specifications						
	iEM2100	iEM2105	iEM2110	iEM2135	iEM2150	iEM2155
Direct connection	63 A	63 A	63 A	63 A	63 A	63 A
Pulse output operation		1 pulse/kwh (200ms long)	1 to 1000 pulses / kwh or kvarh (30 to 100ms long)			
Display capacity	99999 KWh or 999.99 MWh		999999.99KWh			
Voltage range (L-N)	184 to 276 V AC		92 to 276 V AC			
Operating frequency	50/60 Hz					
Meter constant LED	1000 flashes per KWh					
Wiring capacity (Top)	6 mm ²		4 mm ²			
Wiring capacity (Bottom)	32 mm ² (16 mm ² iEM2100/iEM2105)					
Consumption	2.5 VA		3 VA			
IP protection	IP40 front panel and IP20 casing					
Temperature	-25°C to 55°C					
Active energy	■	■	■	■	■	■
Reactive energy			■	■	■	■
Active power			■	■	■	■
Reactive power			■	■	■	■
Power Factor			■	■	■	■
Current and voltage			■	■	■	■
Frequency			■	■	■	■

iEM2100/iEM2105 dimensions

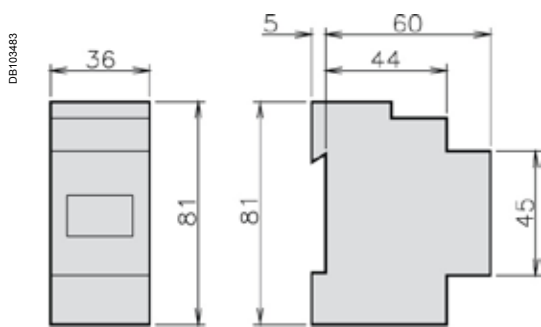

iEM2110/iEM2135/iEM2150/iEM2155 dimensions

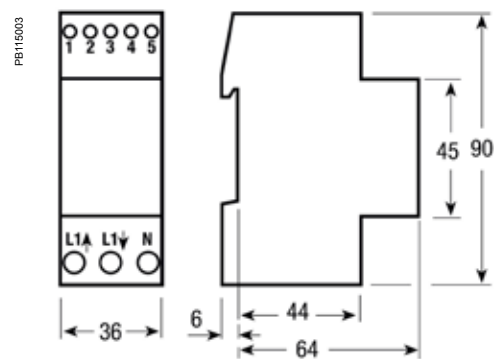

See the appropriate product Installation Guide for complete instructions.

Acti9 iEM3000 Series

The Acti9 iEM3000 series energy meters is a cost-attractive, feature-rich energy metering offer for DIN rail, modular enclosures. With Modbus, BACnet, M-bus and LON protocol support, you can easily integrate these meters into commercial and non-critical buildings to add simple energy management applications to any BMS, AMR or EMS system.

Applications

Cost management applications

- Bill checking to verify that you are only charged for the energy you use
- Sub-billing individual tenants for their energy consumption, including WAGES
- Aggregation of energy consumption, including WAGES, and allocating costs per area, per usage, per shift, or per time within the same facility

Network management applications

- Basic metering of electrical parameters to better understand the behaviour of your electrical distribution system



A9MEM3100

PB108418

More than just kWh meters, the Acti9 iEM3000 series meters provide a full view of both energy consumption and on-site generation with full four-quadrant measurement of active and reactive energy delivered and received. Additionally, extensive real-time measurements (V, I, P, PF) give customers greater detail on their energy usage, and multiple tariffs give customers the flexibility to match the billing structure of their utility.

The solution for

All markets that can benefit from a solution that includes PowerLogic iEM3000 series meters:

- Buildings & industry
- Data centres and networks
- Infrastructure (airports, road tunnels, telecom)

Benefits

Optimise your energy consumption & enable energy efficiency practices

- Collect and analyse energy consumption data from each area for each type of load or circuit
- Gain an accurate understanding of business expenses by allocating the energy-related costs
- Use information to implement actions designed to reduce energy consumption

Monitor the energy consumption of your tenants or customers and establish accurate invoices

- Drive energy-efficient behaviour
- Allow building owners to bill tenants for individual measured utility usage
- Give accurate and achievable objectives for energy savings

Competitive advantages

- Compact size
- MID compliant (selected models) providing certified accuracy and data security
- Programmable digital inputs/outputs
- Multi-tariff capability
- Onboard Modbus, LON, M-bus or BACnet communication
- A complete range of energy meters
- Compatible with Acti9 range

Energy management system:

To get the most effective use from your Schneider Electric measurement and metering devices, we offer a range of dedicated data loggers and gateways for your building energy management.

Conformity of standards

- | | |
|-------------------|--------------|
| • IEC 61557-12 | • EN 50470-3 |
| • IEC 62053-21/22 | • EN 50470-1 |
| • IEC 62053-23 | • IEC 61036 |
| | • IEC 61010 |

Acti9 iEM3000 Series

iEM3000 feature selection		iEM3100 iEM3200 iEM3300	iEM3110 iEM3210 iEM3310	iEM3115 iEM3215	iEM3150 iEM3250 iEM3350	iEM3135 iEM3235 iEM3335	iEM3155 iEM3255 iEM3355	iEM3165 iEM3265 iEM3365	iEM3175 iEM3275 iEM3375
Self-powered		■	■	■	■	■	■	■	■
Width (18mm module)		5/5/7	5/5/7	5/5	5/5/7	5/5/7	5/5/7	5/5/7	5/5/7
Direct measurement (up to)		63 A/-/125 A	63 A/-/125 A	63 A/-	63 A/-/125 A	63 A/-/125 A	63 A/-/125 A	63 A/-/125 A	63 A/-/125 A
Measurement input through CTs (1A, 5A)		- / ■ / -	- / ■ / -	- / ■	- / ■ / -	- / ■ / -	- / ■ / -	- / ■ / -	- / ■ / -
Measurement input through VTs					- / ■ / -	- / ■ / -	- / ■ / -	- / ■ / -	- / ■ / -
Active Energy measurements class		1/0.5S/1	1/0.5S/1	1/0.5S	1/0.5S/1	1/0.5S/1	1/0.5S/1	1/0.5S/1	1/0.5S/1
Four Quadrant Energy measurement						■	■	■	■
Electrical parameter measurements (I, V, P,...)					■	■	■	■	■
Multi-tariff (internal clock)				4		4	4	4	4
Multi-tariff (external control)				4		2	2	2	2
Measurement display (no. of line)		3	3	3	3	3	3	3	3
Digital inputs	Programmable (Tariff control or WAGES input)					1	1	1	1
	Tariff control only			2					
Digital outputs	Programmable (Kwh pulse or KW overload alarm)					1	1	1	
	Kwh pulse only		1						
Communication protocols	M-bus					■			
	Modbus				■		■		
	BACnet							■	
	Lon								■
MID (legal metrology certification)			■	■		■	■	■	■
Commercial reference numbers	A9MEM3100	A9MEM3110	A9MEM3115	A9MEM3150	A9MEM3135	A9MEM3155	A9MEM3165	A9MEM3175	
	A9MEM3200	A9MEM3210	A9MEM3215	A9MEM3250	A9MEM3235	A9MEM3255	A9MEM3265	A9MEM3275	
	A9MEM3300	A9MEM3310		A9MEM3350	A9MEM3335	A9MEM3355	A9MEM3365	A9MEM3375	

See your Schneider Electric representative for complete ordering information.

How to read table: If a cell contains a single value, that value applies to all meter models identified in the header cell(s). For cells with multiple values, the values correspond from left to right with the meter models listed from top to bottom for each associated header cell. For example, a cell with "A / B / C" means A for iEM31xx models, B for iEM32xx models, and C for iEM33xx models

Acti9 iEM3000 Series

EM3400/iEM3500 technical specifications				
	iEM3455	iEM3465	iEM33555	iEM3565
Max current	0.333V-1.0V LVCTs	0.333V-1.0V LVCTs	Rogowski coils	Rogowski coils
Meter constant LED	5000/kWh			
Pulse output frequency	Up to 500p/kWh			
Multi-tariff	4 tariffs			
Communication	Modbus	BACnet	Modbus	BACnet
DI/DO	1/1			
Network	1P+N, 3P, 3P+N support LVCTs, Rogowski coils, and VTs			
Wiring capacity	6 mm ² for currents and 4 mm ² for voltages			
Display max	LCD 99999999.9kWh or 99999999.9MWh			
Voltage (L-L)	3 x 100/173 V AC to 3 x 277/480 V AC (50/60 Hz)			
IP protection	IP40 front panel and IP20 casing			
Temperature	-25°C to 70°C (K55)			
Product size	5 steps of 18 mm			
Overvoltage & measurement	Category III, Degree of pollution 2			
kWh	■			
kVARh	■			
Active power	■			
Reactive power	■			
Currents & voltages	■			
Overload alarm	■			
Hour counter	■			

See your Schneider Electric representative for complete ordering information.

Acti9 iEM3100/iEM3300 series technical specifications

Technical specifications								
	iEM3100 iEM3300	iEM3110 iEM3310	iEM3115	iEM3150 iEM3350	iEM3135 iEM3335	iEM3155 iEM3355	iEM3165 iEM3365	iEM3175 iEM3375
Max current (direct connection)	63 A for iEM3100 models, 125 A for iEM3300 models							
Meter constant LED	500/kWh							
Pulse output		Up to 1000 p/kWh			Up to 1000 p/kWh		Up to 1000 p/kWh	
Multi-tariff			4 tariffs		4 tariffs		4 tariffs	
Communication				Modbus	Modbus	Modbus	BACnet	LON
DI/DO		0/1	2/0		1/1	1/1	1/1	1/0
MID (EN50470-3)		■			■	■	■	■
Network	1P+N, 3R, 3P+N							
Accuracy class	Class 1 (IEC 62053-21 and IEC 61557-12) Class B (EN 50470-3)							
Wiring capacity	16 mm ² for iEM3100 models, 50 mm ² for iEM3300 models							
Display max.	LCD 99999999.9kWh							
Voltage (L-L)	3 x 100/173 V AC to 3 x 277/480 V AC (50/60 Hz)							
IP protection	IP40 front panel and IP20 casing							
Temperature	-25°C to 55°C (K55)							
Product size	5 x 18 mm for iEM3100 models, 7 x 18 mm for iEM3300 models							
Overvoltage and measurement	Category III, Degree of pollution 2							
kWh	■	■	■	■	■	■	■	■
kVARh					■	■	■	■
Active power				■	■	■	■	■
Reactive power					■	■	■	■
Currents and voltages				■	■	■	■	■
Overload alarm					■	■	■	■
Hour counter					■	■	■	■

Acti9 IEM3200 series technical specifications

Technical specifications								
Max current (1A/5A CT connected)	6 A							
Meter constant LED	5000/kWh							
Pulse output frequency	Up to 500p/kWh		Up to 500p/kWh		Up to 500p/kWh			
Multi-tariff	4 tariff			4 tariffs		4 tariffs		
Communication	Modbus			Modbus		Modbus		BACnet LON
DI/DO	0/1		2/0		1/1		1/1	
MID (EN50470-3) ⁽¹⁾	■		■		■		■	
Network	1P+N, 3P, 3P+N support CTs			1P+N, 3P, 3P+N support CTs & VTs				
Accuracy class	Class 0.5S (IEC 62053-22 and IEC61557-12) Class C (EN50470-3) ⁽¹⁾							
Wiring capacity	6 mm ² for currents and 4 mm ² for voltages							
Display max.	LCD 99999999.9kWh or 99999999.9MWh							
Voltage (L-L)	3 x 100/173 V AC to 3 x 277/480 V AC (50/60 Hz)							
IP protection	IP40 front panel and IP20 casing							
Temperature	-25°C to 55°C (K55)							
Product size	5 steps of 18 mm							
Overvoltage & measurement	Category III, Degree of pollution 2							
kWh	■		■		■		■	
kVARh	■		■		■		■	
Active power	■		■		■		■	
Reactive power	■		■		■		■	
Currents and voltages	■		■		■		■	
Overload alarm	■		■		■		■	
Hour counter	■		■		■		■	

⁽¹⁾ Only for iEM32xx used with 5 A CTs.

iEM3000/iEM3200 series dimensions

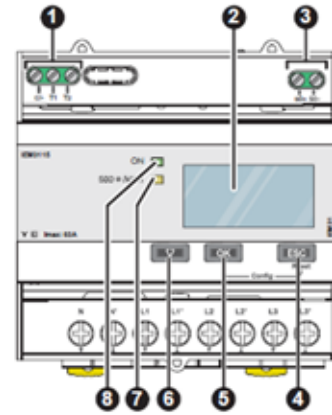
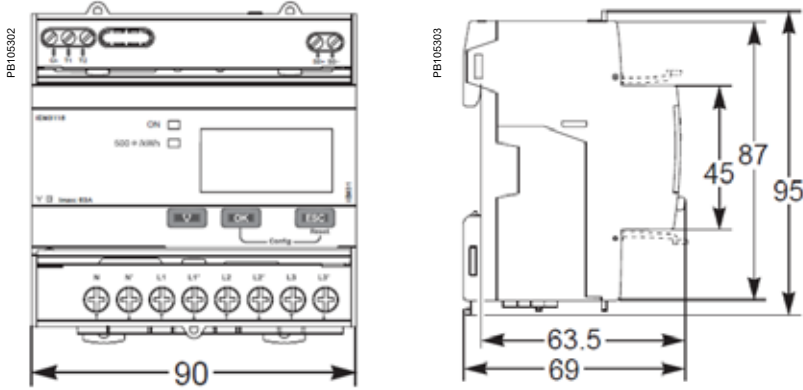

Acti9 iEM3100/iEM3200 Series front flaps open and closed

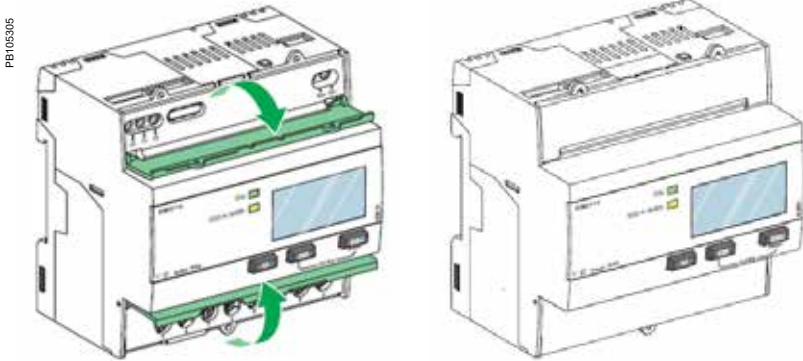

Acti9 iEM3000 Series parts

1. Digital inputs for tariff control (iEM3115 / iEM3215)
2. Display for measurement and configuration
3. Pulse out for remote transfer (iEM3110 / iEM3210)
4. **ESC** Cancellation
5. **OK** Confirmation
6. **V** Selection
7. Flashing yellow meter indicator to check accuracy
8. Green indicator: on/off, error

iEM3300 series dimensions

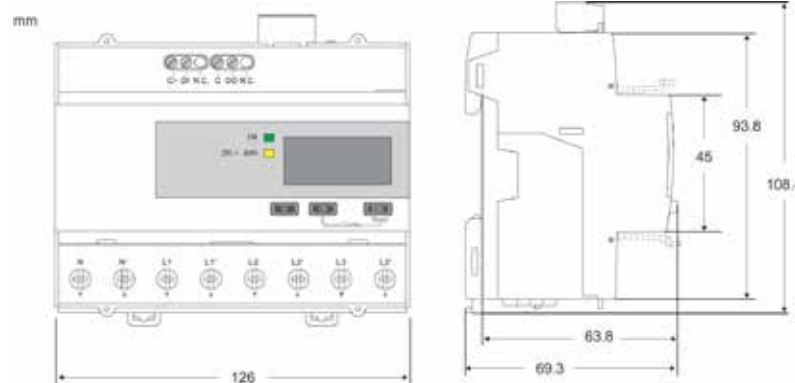
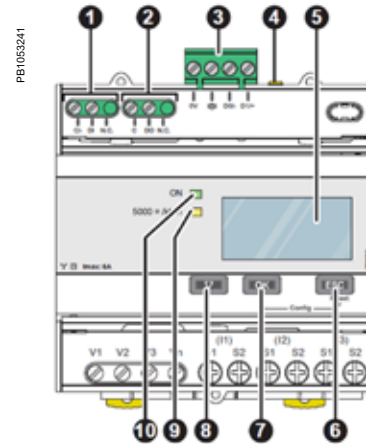
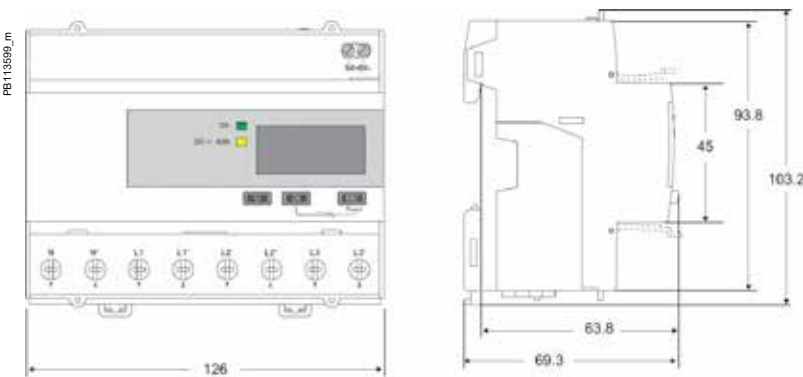

Acti9 iEM3000 Series parts

1. Digital inputs for tariff control (iEM3115 / iEM3215)
2. Display for measurement and configuration
3. Pulse out for remote transfer (iEM3110 / iEM3210)
4. **ESC** Cancellation
5. **OK** Confirmation
6. **V** Selection
7. Flashing yellow meter indicator to check accuracy
8. Green indicator: on/off, error

Please see the appropriate **Installation Guide** for accurate and complete information on the installation of this product.

Basic multi-function metering

A range of meters designed for cost management and simple network management. Affordable to buy and easy to choose, the highly-capable PowerLogic PM5000 series meters are designed to provide the best combination of features to match all your energy cost management needs.

As well as pin-point energy savings, optimal equipment efficiency and utilisation, basic multi-function meters perform a high level assessment of the power quality in an electrical network.

- PowerLogic PM3000
- PowerLogic PM5000

PB108447

PB111770



A9MEM2000



A9MEM2000

PM3000 series

The PowerLogic PM3000 series power meters are a cost-attractive, feature-rich range of DIN rail-mounted power meters that offers all the measurement capabilities required to monitor an electrical installation.

Ideal for power metering and network monitoring applications that seek to improve the availability and reliability of your electrical distribution system, the meters are also fully capable of supporting sub-metering and cost allocation applications.

Applications

Cost management applications

- Bill checking to verify that you are only charged for the energy you use
- Aggregation of energy consumption, including WAGES, and cost allocation per area, per usage, per shift or per time within the same facility
- Energy cost and usage analysis per zone, per usage or per time period to optimise energy usage

Network management applications

- Metering of electrical parameters to better understand the behaviour of your electrical distribution system

PB10947



METSEPM3250

The solution for

All markets that can benefit from a solution that includes PowerLogic PM3000 series meters:

- Buildings
- Industry
- Data centres and networks
- Infrastructure (e.g. airports, road tunnels, telecom)

Benefits

Optimise your energy consumption & enable energy efficiency practices

- Collect and analyse energy consumption data from each area for each type of load or circuit
- Gain an accurate understanding of business expenses by allocating the energy-related costs
- Identify savings opportunities
- Use information to implement actions designed to reduce energy consumption

Competitive advantages

Connectivity advantages

- Programmable digital input
 - External tariff control signal (4 tariff)
 - Remote reset partial counter
 - External status like breaker status
 - Collect WAGES pulses
 - Programmable digital output
 - Alarm (PM3255)
 - KWh pulses
 - Graphic LCD display
 - Modbus RS-485 with screw terminals
- Multi-tariff capability
- The PM3000 series allows users to arrange KWh consumption in four different registers. This can be controlled by:
- Digital inputs. Signal can be provided by PLC or utilities
 - Internal clock programmable by HMI
 - Through communication

This function allows users to:

- Make tenant metering for dual source applications to differentiate backup source or utility source
- Understand well the consumption during peak time and off-peak time, weekdays and weekends, holiday and working days etc.
- Follow up feeders consumption in line with utility tariff rates

Power management solutions

Schneider Electric provides innovative power management solutions to increase your energy efficiency and cost savings, maximise electrical network reliability and availability, and optimise electrical asset performance.

Conformity of standards

- IEC 61557-12
- IEC 61326-1
- IEC 62052-11
- IEC 62053-21
- IEC 62053-22
- IEC 62053-23
- EN 50470-1
- EN 50470-3
- IEC 61010-1
- EN 55022

PM3000 series

PM3000 series feature selection				
	PM3200	PM3210	PM3250	PM3255
Performance standard				
IEC61557-12 PMD/Sx/K55/0.5	■	■	■	■
General				
Use on LV and HV systems	■	■	■	■
Number of samples per cycle	32	32	32	32
CT input 1A/5A	■	■	■	■
VT input	■	■	■	■
Multi-tariff	4	4	4	4
Multi-lingual backlit display	■	■	■	■
Instantaneous rms values				
Current, voltage Per phase and average	■	■	■	■
Active, reactive, apparent power Total and per phase	■	■	■	■
Power factor Total and per phase	■	■	■	■
Energy values				
Active, reactive and apparent energy; import and export	■	■	■	■
Demand				
Current, power (active, reactive, apparent) demand; present	■	■	■	■
Current, power (active, reactive, apparent) demand; peak		■	■	■
Power quality measurements				
THD Current and voltage		■	■	■
Data recording				
Min/max of the instantaneous values	■	■	■	■
Power demand logs				■
Energy consumption log (day, week, month)				■
Alarms with timestamping		5	5	15
Digital inputs/digital outputs		0/1		2/2
Communication				
RS-485 port			■	■
Modbus protocol			■	■
Commercial reference number	METSEPM3200	METSEPM3210	METSEPM3250	METSEPM3255

See your Schneider Electric representative for complete ordering information.

PM3000 series

PM3000 technical specifications	
Type of measurement	True rms up to the 15th harmonic on three-phase (3P,3P+N) and single-phase AC systems. 32 samples per cycle
Measurement accuracy	
Current with x/5A CTs	0.3 % from 0.5 A to 6 A
Current with x/1A CTs	0.5 % from 0.1 A to 1.2 A
Voltage	0.3 % from 50 V to 330 V (Ph-N), from 80 V to 570 V (Ph-Ph)
Power factor	±0.005 from 0.5 A to 6 A with x/5 A CTs; from 0.1A to 1.2 A with x/1 A CTs and from 0.5 L to 0.8 C
Active/Apparent Power with x/5A CTs	Class 0.5
Active/Apparent Power with x/1A CTs	Class 1
Reactive power	Class 2
Frequency	0.05 % from 45 to 65 Hz
Active energy with x/5A CTs	IEC 62053-22 Class 0.5s
Active energy with x/1A CTs	IEC 62053-21 Class 1
Reactive energy	IEC 62053-23 Class 2
Data update rate	
Update rate	1s
Input-voltage characteristics	
Measured voltage	50 V to 330 V AC (direct / VT secondary Ph-N) 80 V to 570 V AC (direct / VT secondary Ph-Ph) up to 1 MV AC (with external VT)
Frequency range	45 Hz to 65 Hz
Input-current characteristics	
CT primary	Adjustable from 1 A to 32767 A
CT secondary	1 A or 5 A
Measurement input range with x/5A CTs	0.05 A to 6 A
Measurement input range with x/1A CTs	0.02 A to 1.2 A
Permissible overload	10 A continuous, 20 A for 10s/hour
Control Power	
AC	100/173 to 277/480 V AC (+/-20%), 3 W/5 VA; 45 Hz to 65 Hz
DC	100 to 300 V DC, 3 W
Input	
Digital inputs (PM3255)	11 to 40 V DC, 24 V DC nominal, <=4mA maximum burden, 3.5kVrms insulation
Output	
Digital output (PM3210)	Optocoupler, polarity sensitive, 5 to 30 V, 15 mA max, 3.5kVrms insulation
Digital outputs (PM3255)	Solid state relay, polarity insensitive, 5 to 40 V, 50 mA max, 50 Ω max, 3.5kVrms insulation

PM3000 series

PM3000 technical specifications	
Mechanical characteristics	
Weight	0.26 kg
IP degree of protection (IEC 60529)	IP40 front panel, IP20 meter body
Dimension	90 x 95 x 70 mm
Environmental conditions	
Operating temperature	-25 °C to 55 °C
Storage temperature	-40 °C to 85 °C
Humidity rating	5 to 95% RH at 50 °C (non-condensing)
Pollution degree	2
Metering category	III, for distribution systems up to 277/480 V AC
Dielectric withstand	As per IEC61010-1, Doubled insulated front panel display
Altitude	3000 m max
Electromagnetic compatibility	
Electrostatic discharge	Level IV (IEC 61000-4-2)
Immunity to radiated fields	Level III (IEC 61000-4-3)
Immunity to fast transients	Level IV (IEC 61000-4-4)
Immunity to surge	Level IV (IEC 61000-4-5)
Conducted immunity	Level III (IEC 61000-4-6)
Immunity to power frequency magnetic fields	0.5mT (IEC 61000-4-8)
Conducted and radiated emissions	Class B (EN 55022)
Safety	
	CE as per IEC 61010-1★
Communication	
RS-485 port	Half duplex, from 9600 up to 38400 baud, Modbus RTU (double insulation)
Display characteristics	
Dimensions (VA)	43 mm x 34.6 mm
Display resolution	128 x 96 dots
Standard compliance	
	IEC 61557-12, EN 61557-12 IEC 61010-1, UL 61010-1 IEC 62052-11, IEC 62053-21, IEC 62053-22, IEC 62053-23 EN 50470-1, EN 50470-3

★ Protected throughout by double insulation

PM3200 series front of meter

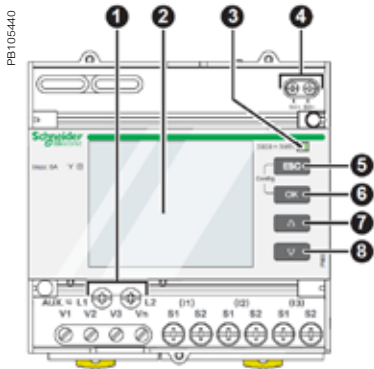

Front of meter parts

- 1 Control power
- 2 Display with white backlight
- 3 Flashing yellow meter indicator (to check accuracy)
- 4 Pulse output for remote transfer (PM3210)
- 5 ESC Cancellation
- 6 OK Confirmation
- 7 Up
- 8 Down

PM3200 series dimensions



mm

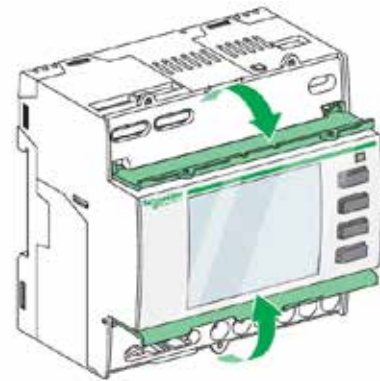
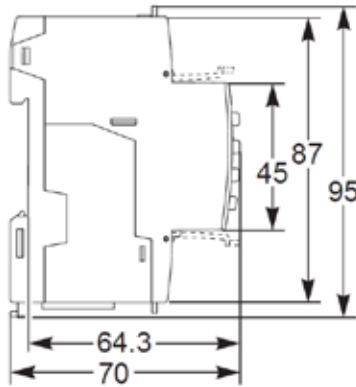

PM3200 top and lower flaps

PM3200 series easy installation

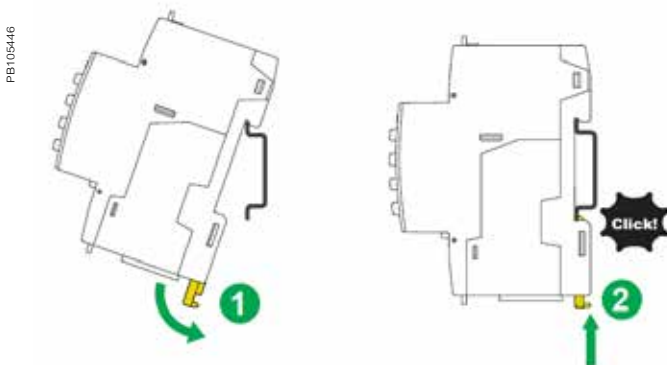

Please see the appropriate **Installation Guide** for accurate and complete information on the installation of this product.

Rear of meter - open



Rear view retainers - installation

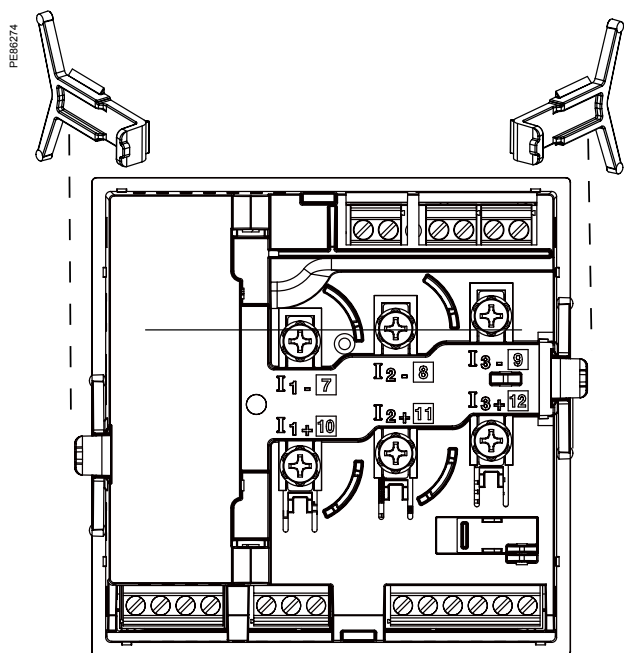

Rear view retainers - users

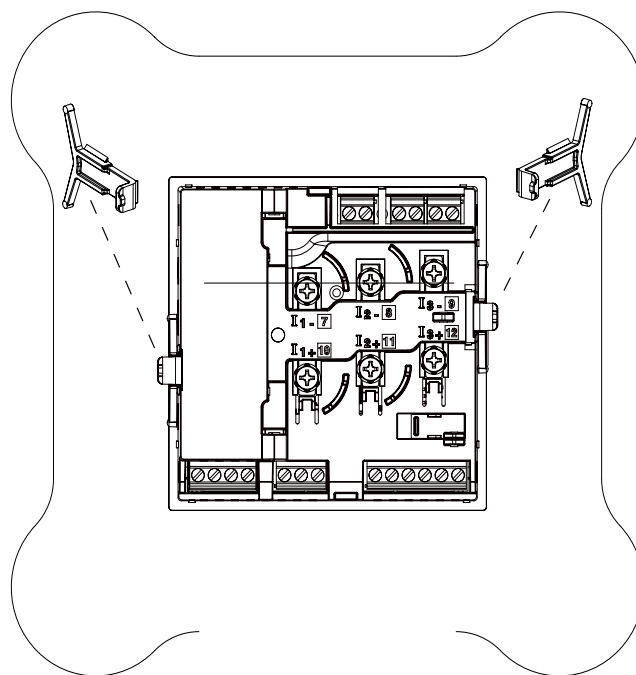

For detailed installation instructions see the product's Installation Guide.

PM5000 series

The PowerLogic PM5000 series power meters are the new benchmark in affordable, precision metering.

The value you want, the precision you need. Compact, affordable power meters with high-end cost capabilities and basic mobile energy management.

Applications

Capable of essential cost management:

- Sub-billing/tenant metering
- Equipment sub-billing
- Energy cost allocation

Also ideal for electrical network management:

- Track real-time power conditions
- Monitor control functions
- Provide basic power quality values
- Monitor equipment and network status
- BACnet/IP protocol support



METSEPM5100

The solution for

Markets that can benefit from a solution that includes PowerLogic PM5000 series meters:

- Buildings
- Industry
- Healthcare
- Data Centre and networks
- Infrastructure

Benefits

System integrators' benefit

- Ease of integration
- Ease of setup
- Cost effectiveness

Panel builders' benefit

- Ease of installation
- Cost effectiveness
- Aesthetically pleasing
- Simplified ordering

End users' benefit

- Ease of use
- Precision metering & sub-billing
- Billing flexibility
- Comprehensive, consistent and superior performance

Competitive advantages

- Easy to install and operate
- Easy for circuit breaker monitoring and control
- Direct metering of neutral circuit and calculated ground current value to avoid overload and resulting outage (PM556x)
- Power quality analysis
- Load management combined with alarm and timestamping
- High performance and accuracy
- MID ready compliance for legal billing application
- BACnet/IP protocol support

Power management solutions

Schneider Electric provides innovative power management solutions to increase your energy efficiency and cost savings, maximise electrical network reliability and availability, and optimise electrical asset performance. See Page 114

Conformity of standards

- IEC 61557-12
- IEC 61010-1
- IEC 62053-22
- IEC 61326-1
- IEC 62053-24
- CISPR22
- EN 50470-1
- Class B
- EN 50470-3

PM5000 series

PM5000 series feature selection

	PM5100		PM5300				PM5500		
	PM5100	PM5110	PM5310	PM5320	PM5330	PM5340	PM5560	PM5563	PM5563RD
Installation									
Fast installation, panel mount with integrated display	■	■	■	■	■	■	■	-	-
Fast installation, DIN rail mountable	-	-	-	-	-	-	-	■	■
Accuracy	CL 0.5S	CL 0.5S	CL 0.5S	CL 0.5S	CL 0.5S	CL 0.5S	CL 0.2S	CL 0.2S	CL 0.2S
Display									
Backlit LCD, multilingual, bar graphs, 6 lines, 4 concurrent values	■	■	■	■	■	■	■	■	■
Power and energy metering									
3-phase voltage, current, power, demand, energy, frequency, power factor	■	■	■	■	■	■	■	■	■
Multi-tariff	-	-	4	4	4	4	8	8	8
Power quality analysis									
THD, thd, TDD	■	■	■	■	■	■	■	■	■
Harmonics, individual (odd) up to	15th	15th	31st	31st	31st	31st	63rd	63rd	63rd
I/Os and relays									
I/Os	1DO	1DO	2DI/2DO	2DI/2DO	2DI/2DO	2DI/2DO	4DI/2DO	4DI/2DO	4DI/2DO
Relays	0	0	0	0	2	2	0	0	0
Alarms and control									
Alarms	33	33	35	35	35	35	52	52	52
Set point response time, seconds	1	1	1	1	1	1	1	1	1
Single and multi-condition alarms	-	-	■	■	■	■	■	■	■
Boolean alarm logic	-	-	-	-	-	-	■	■	■
Memory for data logging			256KB	256KB	256KB	256KB	1.1 MB	1.1 MB	1.1 MB
Communications									
Serial ports with modbus protocol	-	1	1	-	1	-	1	1	1
Ethernet port with Modbus TCP protocol	-	-	-	1	-	1	2★★	2★★	2★★
BACnet/IP protocol	-	-	-	■	-	■	■	■	■
Onboard web server with web pages	-	-	-	-	-	-	■	■	■
Serial to Ethernet gateway	-	-	-	-	-	-	■	■	■
MID ready compliance, EN50470-1/3, Annex B and Annex D Class C	-	PM5111 METSEPM5111	-	-	PM5331 METSEPM5331	PM5341 METSEPM5341	PM5561 METSEPM5561	PM5561 METSEPM5561	PM5561
Short reference numbers	PM5100	PM5110	PM5310	PM5320	PM5330	PM5340	PM5560	PM5563	PM5563RD
Commercial reference numbers	METSEPM5100	METSEPM5110	METSEPM5310	METSEPM5320	METSEPM5330	METSEPM5340	METSEPM5560	METSEPM5563	

★★ 2 Ethernet ports for daisy chain, one IP address

Other related products

Commercial reference numbers	Description
METSEPM5563RD	PM5563 meter with remote display
METSEPM5RD	Remote display for PM5563
METSEPM51HK	Hardware kit for PM51xx
METSEPM53HK	Hardware kit for PM53xx
METSEPM51_3RSK	Revenue sealing kit for PM51XX & PM53XX
METSEPM55RSK	Revenue sealing kit for PM55XX
METSEPM55HK	Hardware kit for PM55xx
METSEPM5CAB3	Remote Display cable

See your Schneider Electric representative for complete ordering information.

PM5000 series

PM5000 technical specifications

		PM5100	PM5300	PM5500
Use on LV and MV systems			■	
Basic metering with THD and min/max readings			■	
Instantaneous rms values				
Current	per phase, neutral and ground (PM5500)		■	
Voltage	Total, per phase L-L and L-N		■	
Frequency			■	
Real, reactive, and apparent power	Total and per phase		Signed, Four Quadrant	
True Power Factor	Total and per phase		Signed, Four Quadrant	
Displacement PF	Total and per phase		Signed, Four Quadrant	
% Unbalanced I, V L-N, V L-L			■	
Direct monitoring of neutral current				■
Energy values				
Accumulated Active, Reactive and Apparent Energy		Received/Delivered; Net and absolute; Time Counters		
Demand value				
Current average		Present, Last, Predicted, Peak, and Peak Date Time		
Active power		Present, Last, Predicted, Peak, and Peak Date Time		
Reactive power		Present, Last, Predicted, Peak, and Peak Date Time		
Apparent power		Present, Last, Predicted, Peak, and Peak Date Time		
Peak demand with timestamping D/T for current and powers			■	
Demand calculation	Sliding, fixed and rolling block, thermal methods		■	
Synchronisation of the measurement window to input, communication command or internal clock			■	
Settable Demand intervals			■	
Demand calculation for Pulse input (WAGES)				■
Other measurements				
I/O timer			■	
Operating timer			■	
Load timer			■	
Alarm counters and alarm logs			■	
Power quality measurements				
THD, thd (Total Harmonic Distortion) I, VLN, VLL			I, VLN, VLL	
TDD (Total Demand Distortion)			■	
Individual harmonics (odds)		15th	31st	63rd
Neutral Current metering with ground current calculation				■
Data recording				
Min/max of instantaneous values, plus phase identification★			■	
Alarms with 1s timestamping★			■	
Data logging			2 fixed parameters kWh and kWh with configurable interval and duration (e.g. 2 parameters for 60 days at 15 minutes interval)	Up to 14 selectable parameters with configurable interval and duration (e.g. 6 parameters for 90 days at 15 minutes interval)
Memory capacity			256 kB	1.1 MB
Min/max log		■	■	■
Maintenance, alarm and event logs			■	■
Customisable data logs				■

★Stored in non-volatile memory

PM5000 series

PM5000 technical specifications

		PM5100	PM5300	PM5500
Inputs / Outputs / Mechanical Relays				
Digital inputs			2 (SI1, SI2)	4 (SI1, SI2, SI3, SI4) with WAGES support
Digital outputs		1 (kWh only)	2 (configurable)	2 (configurable)
Form A Relay outputs			2	
Timestamp resolution in seconds		1	1	1
Whetting voltage			■	
Type of measurement: True rms on three-phase (3R, 3P + N)		64 samples per cycle		128 samples per cycle
Measurement accuracy	IEC 61557-12	PMD/[SD SS]/K70/0.5		PMD/[SD SS]/K70/0.2
	Active Energy	Class 0.5S as per IEC 62053-22		Class 0.2S as per IEC 62053-22
	Reactive Energy	Class 2S as per IEC 62053-24		Class 1S as per IEC 62053-24
	Active Energy	±0.5%		±0.2%
	Reactive Energy	±2%		±1%
	Active Power	Class 0.5 as per IEC 61557-12		Class 0.2 as per IEC 61557-12
	Apparent Power	Class 0.5 as per IEC 61557-12		
	Current, Phase	Class 0.5 as per IEC 61557-12		±0.15%
	Voltage, L-N	Class 0.5 as per IEC 61557-12		±0.1%
	Frequency	±0.05%		
	MID Directive EN50470-1, EN50470-3	Annex B and Annex D (Optional model references) Class C		
Input-voltage (up to 1.0 MV AC max, with voltage transformer)	Nominal Measured Voltage range	20 V L-N / 35 V L-L to 400 V L-N /690 V L-L absolute range 35 V L-L to 760 V L-L		20 V L-N / 20 V L-L to 400 V L-N /690 V L-L absolute range 20 V L-L to 828 V L-L
	Impedance	5 M Ω		
	F nom	50 or 60 Hz ±5%		50 or 60 Hz ±10%
Input-current (configurable for 1 or 5 A secondary CTs)	I nom	5 A		
	Measured Amps with over range and Crest Factor	Starting current: 5 mA Operating range: 50 mA to 8.5 A		Starting current: 5m A Operating range: 50 mA to 10 A
	Withstand	Continuous 20 A, 10 s/hr 50 A, 1s/hr 500 A		
	Impedance	< 0.3 mΩ		
	F nom	50 or 60 Hz ±5%		50 or 60 Hz ±10%
	Burden	<0.026 VA at 8.5 A		
AC control power	Operating range	100 - 277 V AC L-N / 415 V L-L +/-10% CAT III 300V class per IEC 61010		100-480 V AC ±10% CAT III 600V class per IEC 61010
	Burden	<5 W,11 VA at 415V L-L		<5W/16.0 VA at 480 V AC
	Frequency	45 to 65 Hz		
	Ride-through time	80 mS typical at 120V AC and maximum burden. 100 mS typical at 230 V AC and maximum burden 100 mS typical at 415 V AC and maximum burden		35 ms typical at 120 V L-N and maximum burden 129 ms typical at 230 V L-N and maximum burden
DC control power	Operating range	125-250 V DC ±20%		
	Burden	<4 W at 250 V DC		typical 3.1W at 125 V DC, max. 5W
	Ride-through time	50 mS typical at 125 V DC and maximum burden		

PM5000 series

PM5000 technical specifications

		PM5100	PM5300	PM5500
Relay	Max output frequency		0.5 Hz maximum (1 second ON / 1 second OFF - min times)	
	Switching current		250 V AC at 8.0 Amps, 25 k cycles, resistive 30 V DC at 2.0 Amps, 75 k cycles, resistive 30 V DC at 5.0 Amps, 12.5 k cycles, resistive	
	Isolation		2.5 kV rms	
Outputs	Digital outputs	1	2	2
	Max load voltage	40 V DC		30 V AC / 60 V DC
	Max load current	20 mA		125 mA
	On Resistance	50 Ω max		8 Ω
	Meter constant	from 1 to 9,999,999 pulses per kWh		
	Pulse width for Digital Output	50% duty cycle		
	Pulse frequency for Digital Output	25 Hz max.		
	Leakage current	0.03 micro Amps		1 micro Amps
	Isolation	5 kV rms		2.5 kV rms
	Optical outputs	Pulse width (LED)	200 ms	
Pulse frequency		50 Hz. max.		2.5 kHz. max
Meter constant		from 1 to 9,999,999 pulses per k_h		
Status Inputs	ON Voltage		18.5 to 36 V DC	30 V AC / 60 V DC max
	OFF Voltage		0 to 4 V DC	
	Input Resistance		110 k Ω	100 k Ω
	Maximum Frequency		2 Hz (T ON min = T OFF min = 250 ms)	25 Hz (T ON min = T OFF min = 20 ms)
	Response Time		20 ms	10 ms
	Opto Isolation		5 kV rms	2.5 kV rms
	Wetting output		24 V DC/ 8 mA max	
	Input Burden		2mA @24V DC	2 mA @ 24 V AC/DC
Mechanical characteristics				
Product weight		380 g	430 g	450 g
IP degree of protection (IEC 60529)		IP52 front display, IP30 meter body		
Dimensions W x H x D [protrusion from cabinet]		96 x 96 x 72 mm (77 mm for PM5500) (depth of meter from housing mounting flange) [13 mm]		
Mounting position		Vertical		
Panel thickness		6 mm maximum		
Environmental characteristics				
Operating temperature	Meter	-25 °C to 70 °C		
	Display (Display functions to -25° with reduced performance)	-25 °C to 70 °C		
Storage temp.		-40 °C to 85 °C		
Humidity range		5 to 95 % RH at 50 °C (non-condensing)		
Pollution degree		2		
Altitude		2000 m CAT III / 3000 m CAT II		3000 m max. CAT III

PM5000 technical specifications

Electromagnetic compatibility	
Harmonic current emissions	IEC 61000-3-2
Flicker emissions	IEC 61000-3-3
Electrostatic discharge	IEC 61000-4-2
Immunity to radiated fields	IEC 61000-4-3
Immunity to fast transients	IEC 61000-4-4
Immunity to surge	IEC 61000-4-5
Conducted immunity 150kHz to 80MHz	IEC 61000-4-6
Immunity to magnetic fields	IEC 61000-4-8
Immunity to voltage dips	IEC 61000-4-11
Radiated emissions	FCC part 15, EN 55022 Class B
Conducted emissions	FCC part 15, EN 55022 Class B

Safety	PM5100	PM5300	PM5500
Europe	CE, as per IEC 61010-1 Ed. 3, IEC 62052-11 & IEC 61557-12		
U.S. and Canada	cULus as per UL 61010-1 (3rd Edition)		
Measurement category (Voltage and Current inputs)	CAT III up to 400 V L-N / 690 V L-L		
Dielectric	As per IEC/UL 61010-1 Ed. 3		
Protective Class	II, Double insulated for user accessible parts		

Communication	
RS-485 port Modbus RTU, Modbus ASCII (7 or 8 bit), JBUS	2-Wire, 9600,19200 or 38400 baud, Parity - Even, Odd, None, 1 stop bit if parity Odd or Even, 2 stop bits if None; (Optional in PM51x and PM53x)
Ethernet port: 10/100 Mbps; Modbus TCP/IP	1 Optional 2 (daisy chain only, 1 IP address)
Firmware and language file update	Meter firmware update via the communication ports
Isolation	2.5 kVrms, double insulated

Human machine interface	
Display type	Monochrome Graphics LCD
Resolution	128 x 128
Backlight	White LED
Viewable area (W x H)	67 x 62.5 mm
Keypad	4-button
Indicator Heartbeat / Comm activity	Green LED
Energy pulse output / Active alarm (configurable)	Optical, amber LED
	Wavelength 590 to 635 nm
	Maximum pulse rate 2.5 kHz

Commercial ref. numbers	Description
METSEPM5100	Power Meter range 72 mm depth, control power to 415 V AC, CI 0.5S, 15th harmonic, no communication, 1DO
METSEPM5110	Power Meter range 72 mm depth, control power to 415 V AC, CI 0.5S, 15th harmonic, RS-485 Modbus, 1DO
METSEPM5111	Power Meter range 72 mm depth, control power to 415 V AC, CI 0.5S, 15th harmonic, RS-485 Modbus, 1DO, MID cert.
METSEPM5310	Power Meter range 72 mm depth, control power to 415 V AC, CI 0.5S, 31st harmonic, 256 kB, RS-485 Modbus, 2DI/2DO
METSEPM5320	Power Meter range 72 mm depth, control power to 415 V AC, CI 0.5S, 31st harmonic, 256 kB, Ethernet, 2DI/2DO
METSEPM5330	Power Meter range 72 mm depth, control power to 415 V AC, CI 0.5S, 31st harmonic, 256 kB, RS-485 Modbus, 2DI/2DO, 2Relay
METSEPM5331	Power Meter range 72 mm depth, control power to 415 V AC, CI 0.5S, 31st harmonic, 256 kB, RS-485 Modbus, 2DI/2DO, 2Relay, MID cert.
METSEPM5340	Power Meter range 72 mm depth, control power to 415 V AC, CI 0.5S, 31st harmonic, 256 kB, Ethernet, 2DI/2DO, 2Relay
METSEPM5341	Power Meter range 72 mm depth, control power to 415 V AC, CI 0.5S, 31st harmonic, 256 kB, Ethernet, 2DI/2DO, 2Relay, MID cert.
METSEPM5560	Power Meter range 77 mm depth, control power to 480 V AC, CI 0.2S, 63rd harmonic, 1.1 MB, Modbus and Ethernet, 4DI/2DO
METSEPM5561	Power Meter range 77 mm depth, control power to 480 V AC, CI 0.2S, 63rd harmonic, 1.1 MB, Modbus and Ethernet, MID cert.
METSEPM5562	Power Meter range 77 mm depth, control power to 480 V AC, CI 0.2S, 63rd harmonic, 1.1 MB, RMICAN approved, HW lockable, 4DI/2DO
METSEPM5562MCO	Power Meter range 77 mm depth, control power to 480 V AC, CI 0.2S, 63rd harmonic, 1.1 MB, RMICAN approved, factory sealed, 4DI/2DO
METSEPM5563	Power Meter range 77 mm depth, control power to 480 V AC, CI 0.2S, 63rd harmonic, 1.1 MB, DIN mount, no display, 4DI/2DO

PM5000 Series meter flush mounting

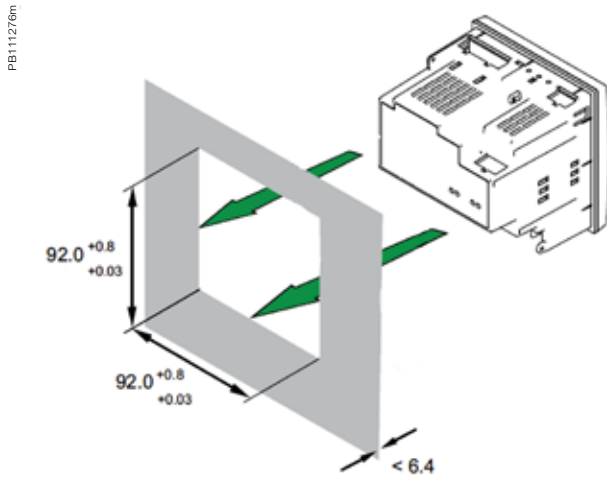

PM5000 series meter dimensions

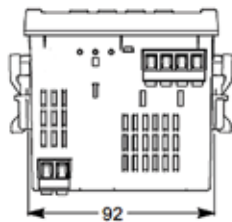
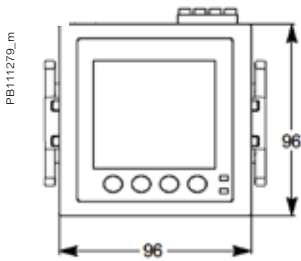

PM5000

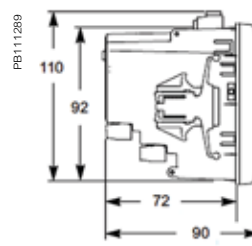

PM5100 / PM5300

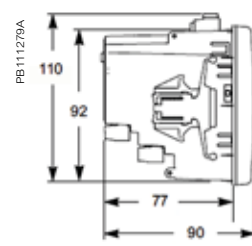

PM5500



- PM5000 meter parts**
- A Menu selection buttons
 - B LED indicators
 - C Navigation or menu selections
 - D Maintenance and alarm notification area

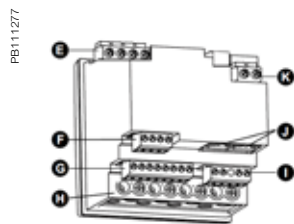

- PM5500 meter parts**
- E Voltage inputs
 - F RS-485 comms
 - G Digital inputs
 - H Current inputs
 - I Digital outputs
 - J Ethernet ports
 - K Control power

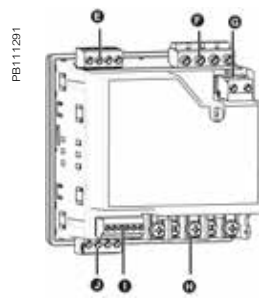

- PM5100 / PM5300 meter parts**
- E Relay output (PM5300 only)
 - F Voltage inputs
 - G Control power
 - H Current inputs
 - I Status inputs/digital outputs
 - J Communications port: Ethernet (PM5300 only) or RS-485

Please see the appropriate *Installation Guide* for accurate and complete information on the installation of this product.

Communications & Gateways

Data loggers, gateways and remote terminal units help measured data reach the power monitoring software for analyses.

They are fundamental components in most power and energy management system architectures.

- Link150 Ethernet gateway
- Data logger Com'X 210
- Data logger Com'X 510



EGX150



EBX210

Serial link

With Schneider Electric’s advanced communication technology, all forms of power monitoring data can be accessed remotely, quickly and easily.

In all architectures, the communication interface serves as the link between the installation devices and the PC running the operating software. It provides the physical link and protocol adaptation. Adaptation is required because the communication systems used by the PC (Modbus via RS-232 and/or Ethernet) are generally not those used by the installation devices (e.g. the Modbus protocol via RS-485).

Dedicated application software prepares the information for analysis under the best possible conditions.

In addition, an Modbus-Ethernet gateway in serial port slave mode allows a serial Modbus master device to access information from other devices across a Modbus TCP/IP network.

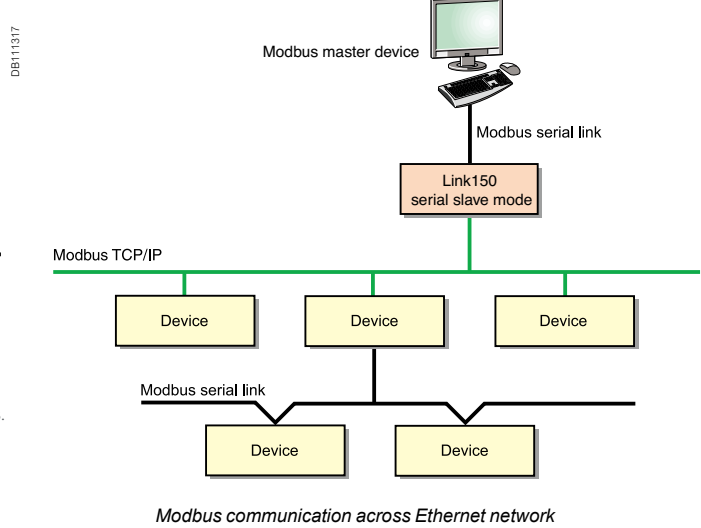
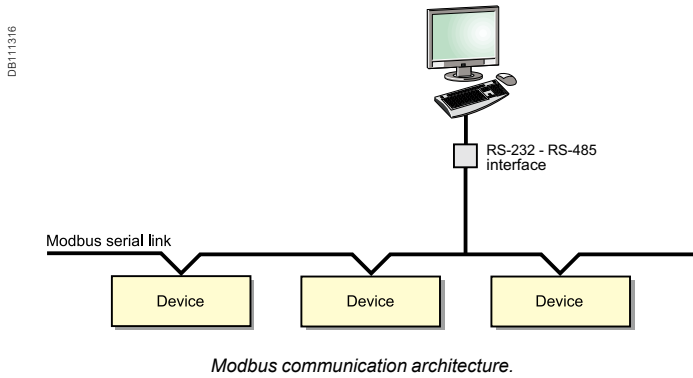

Switchboard-data acquisition and monitoring make it possible to anticipate events. In this way, they reduce customer costs in terms of operation, maintenance and investment.

Ethernet link

Using modern web technologies, the operator can access information from monitoring and protection devices using any PC connected to the network, with all the required security.

The Ethernet Modbus-Ethernet gateway* or the integrated gateway-servers* provide connectivity between Modbus RS-485 and Ethernet Modbus TCP/IP.

PB11133a

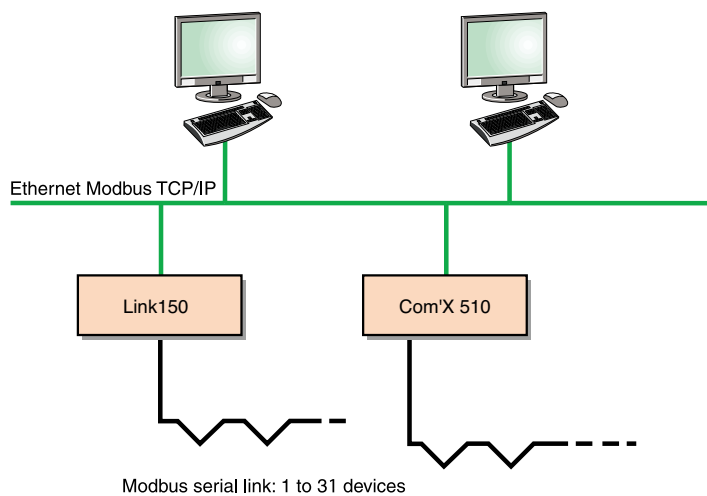

Ethernet communication architecture.

The services available with these technologies considerably simplify the creation, maintenance and operation of these supervision systems.

The application software is now standardised: the web interface into the system does not require custom web pages to be created. It is personalised by simply identifying the components in your installation and can be used as easily as any internet application.

The first step in this approach is the integrated gateway-server with HTTP pages. Power management software (EcoStruxure™ Power Monitoring Expert and EcoStruxure™ Power SCADA Operation), running on a PC, provide broader coverage for more specific need

Link150 Ethernet gateway

The Link150 gateway provides fast, reliable Ethernet connectivity in the most demanding applications, from a single building to a multi-site enterprise. This gateway supports meters, monitors, protective relays, trip units, motor controls and other devices that need to communicate data quickly and efficiently. It is your simple, cost-effective serial line to full Ethernet connectivity.

Applications

- Energy management
- Power distribution
- Building automation
- Factory automation

PB11427



EGX150

The solution for

All markets that can benefit from a solution that includes the Link150 gateway:

- Buildings
- Data centre
- Healthcare
- Industry
- Infrastructure
- Utility

Benefits

- Easy to install and setup
- Easy to maintain
- Advanced security feature
- Compatible with Schneider Electric software offerings
- Reliable Modbus to Ethernet protocol conversion

Energy and power management software

Powerlogic software is recommended as a user interface which provides access to all status and measurement information. It also prepares summary reports for energy and power management. The Link150 is compatible with

- EcoStruxure™ Power Monitoring Expert software
- EcoStruxure™ Power SCADA Operation

Conformity of standards

- EN 55022/EN 55011/ FCC Class A
- EN 61000-6-2
- EN 61000-4-2
- EN 61000-4-3
- EN 61000-4-4
- EN 61000-4-5
- EN 61000-4-6
- EN 61000-4-8
- EN 60950

PB117746

Architecture

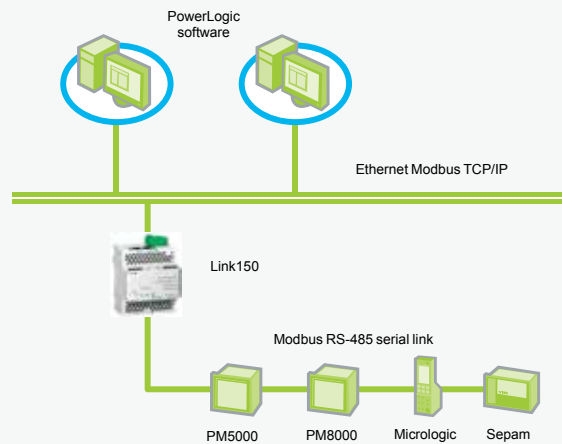

Security

- Secure user interface including user's name and password for login
- Advanced security features to allow users to specify which Modbus TCP/IP master devices may access attached serial slave devices
- Modbus TCP/IP filtering feature
- Allows user to specify the level of access for each master device as Read-only or Full access
- Web pages provide easy configuration and setup

Commercial ref. no.	Product description
EGX150	Link150 Ethernet Gateway

Link150 Ethernet gateway

Technical specifications

Link150	
Weight	175 g without packing
Dimensions (HxWxD)	72 x 105 x 71 mm
Mounting	DIN rail
Power-over-Ethernet (PoE)	Class 3
Power supply	24 V DC (-20/+10 %) or Power over Ethernet (PoE Class 3 IEEE 802.3 af) at 15 W
Consumption (typical)	24 V DC, 130 mA at 20 °C PoE 48 V DC, 65 mA at 20 °C
Ambient operating temperature	-25 to 70 °C
Ambient storage temperature	-40 to 85 °C
Humidity rating	5 % to 95 % relative humidity (without condensation) at +55°C
Pollution Degree	Level 2
IP Ratings	On the front panel (wall-mounted enclosure): IP4x Connectors: IP20 Other parts: IP30
Regulatory/standards compliance for electromagnetic interference	
Emissions (radiated and conducted)	EN 55022/EN 55011/FCC class A
Immunity for industrial environments:	
electrostatic discharge	EN 61000-6-2
radiated RF	EN 61000-4-2
electrical fast transients	EN 61000-4-3
surge	EN 61000-4-4
conducted RF	EN 61000-4-5
power frequency	EN 61000-4-6
magnetic field	EN 61000-4-8
Regulatory/standards compliance for safety	
Safety - IEC	IEC 60950
Safety - UL★	UL 60950 UL 61010-2-201
EMC	IEC 6100-6-2
Australia	C-tick - RCM
Sustainability	Green Premium
Serial ports	
Number of ports	2 (1 available at a time)
Types of ports	RS-232 or RS-485 (2-wire or 4-wire), depending on settings
Protocol	Modbus, Serial
Baud rates	19200 bps (factory setting), 2400 bps, 4800 bps, 9600 bps, 38400 bps, 56000 bps★★, 57600 bps★★
Maximum number of connected devices	32 (directly) 247 (indirectly)
Ethernet ports (used as a switch)	
Number of ports	2
Type of port	10/100BASE-TX (802.3af) por
Protocol	HTTP, Modbus TCP/IP, FTP, SNMP (MIB II)

★ Dual listed for US and Canada

★★ Only available when Physical Interface is set to RS-232 and Transmission Mode is set to Modbus ASCII

Link150 Ethernet gateway

Parts

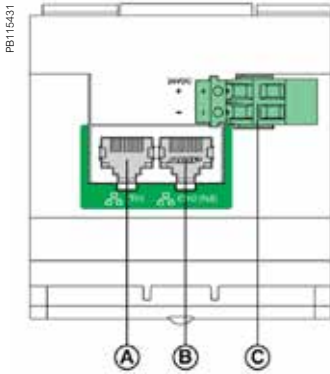

- Ⓐ Ethernet 1 communication port
- Ⓑ Ethernet 2 (PoE) communication port
- Ⓒ Midspan PoE injector

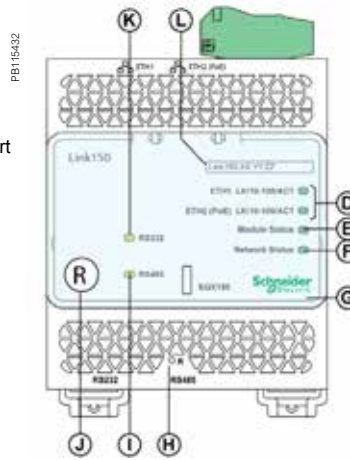

- Ⓓ Ethernet communication LEDs
- Ⓔ Module status LED
- Ⓕ Network status LED
- Ⓖ Sealable transparent cover
- Ⓗ Reset pin
- Ⓘ RS-485 traffic status LED
- ⓵ Device soft restart button (Accessible through closed cover)
- Ⓚ RS-232 traffic status LED
- Ⓛ Device name label

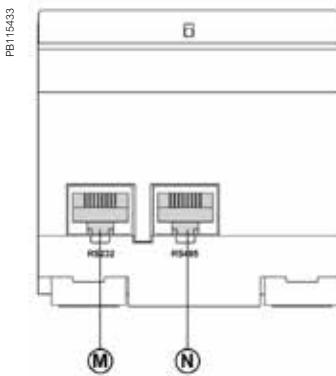

- Ⓜ RS-232 port
- Ⓝ RS-485 port

Dimensions

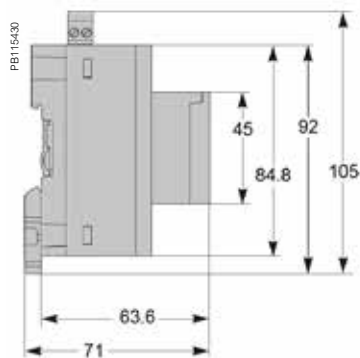

DIN rail mounting

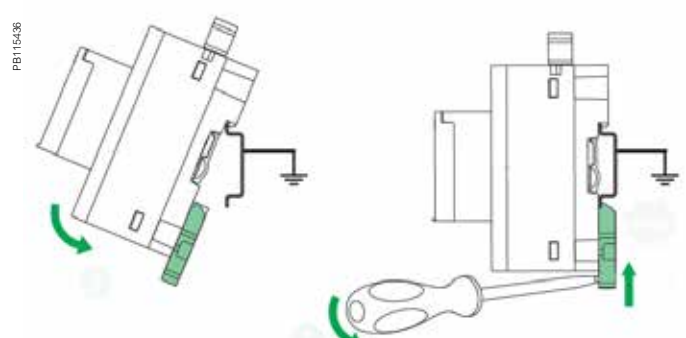

Fast and easy DIN rail installation

See appropriate Installation Guide for this product.

Com'X 210

A highly flexible plug-and-play Energy Server Com'X 210 collects and stores WAGES consumptions and environmental parameters such as temperatures, humidity and CO₂ levels in a building. Data is periodically transmitted as a report to an internet database server for further processing. The Energy Server Com'X 210 not only reduces your technical complexity, but helps to manage your energy.

Applications

The quickest path to multi-site energy management and on-line services

- Delivers batches of data ready to process by EcoStruxure™ Power Management solutions and services
- Publishes logged data to the Schneider Electric cloud or another hosted platform

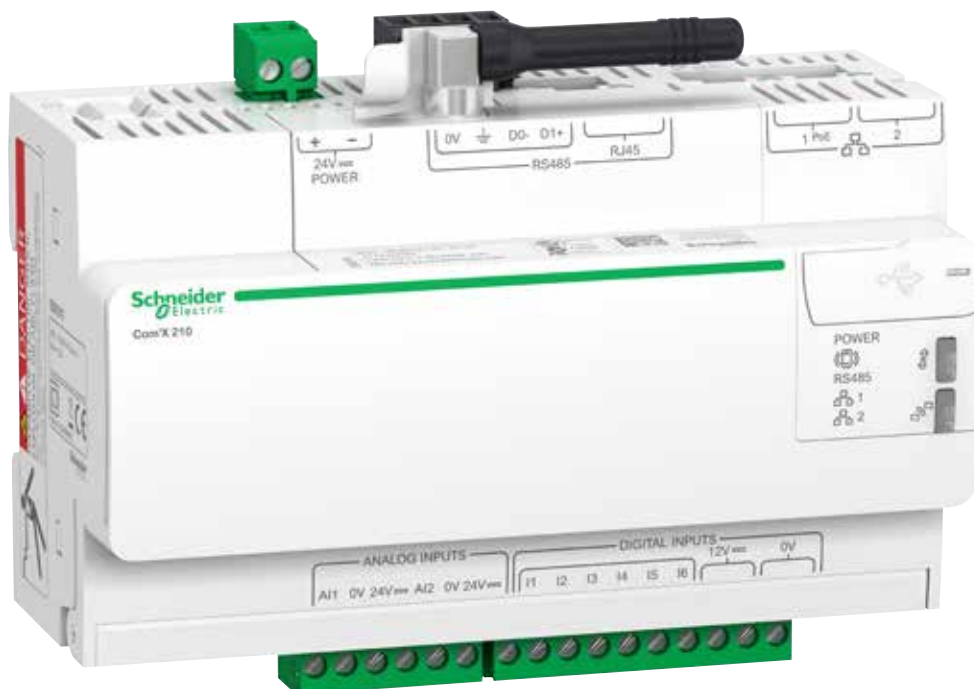

EBX210

The solution for

All markets that can benefit from a solution that includes data logger Com'X 210:

- Buildings
- Industry

Benefits

- Data collection from up to 64 field devices
- Data publishing leveraging existing infrastructures, Ethernet or Wi-Fi, GPRS-ready
- Quick fitting into electrical switchboards thanks to DIN rail clipping and profile
- Quick setup and configuration thanks to intuitive HMI

Energy management solutions

The data collected and stored by Com'X 210 can be processed and displayed as webpages through web services provided by Schneider Electric, such as EcoStruxure™ Power Management software products, or by any private energy platform.

The Com'X 210 also provides a transparent interface between Ethernet-based networks and field devices. This gateway function supports the use of monitoring software, such as EcoStruxure™ Power Monitoring Expert (PME) for data collection, trending, event management, analysis and further processing.

Conformity of standards

- EN 60950

Architecture

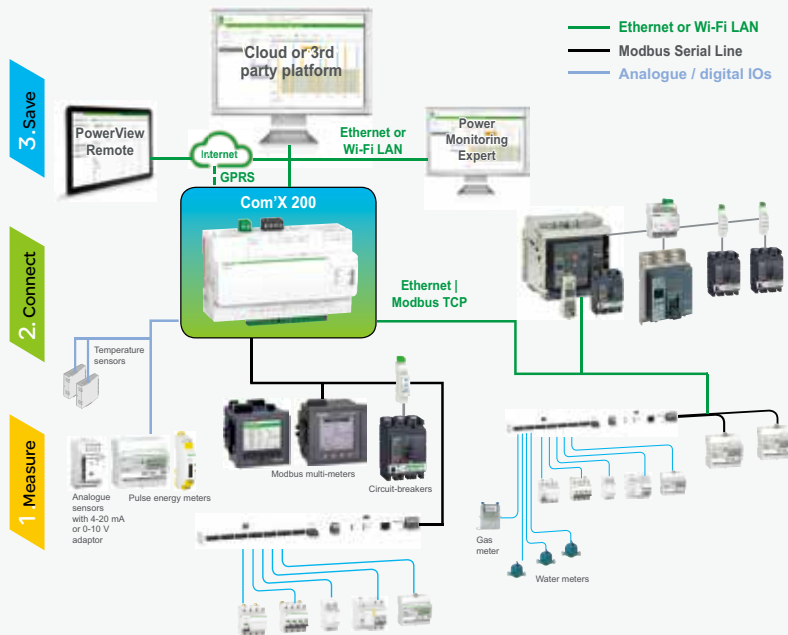

PB114656-200

Data collector

Collects and stores energy data from up to 64 field devices, connected to either:

- Ethernet TCP/IP field network.
- Modbus Serial line network (up to 32 devices).
- Embedded digital and analogue inputs.

“Field devices” consist of :

- PowerLogic devices for power and energy monitoring.
- Masterpact or Compact circuit-breakers for protection and monitoring.
- Acti9 protection devices, meters, remote controlled switches, etc.
- Water, Air, Gas, Electricity, and Steam (WAGES) consumption meters, from specialised manufacturers, delivering pulses as per standard (see table next page).
- Environmental sensors such as temperatures, humidity, and CO₂ levels in a building, providing analogue information.

Data logging and storage capabilities include:

- Configurable logging interval, from every minute to once a week.
- Data storage duration of several weeks, depending on quantity of collected data.

Data publisher

Batches of collected data periodically transmitted to an Internet server, as:

- XML files, for processing by EcoStruxure™ Power Management software products.
- CSV files for viewing in Excel or transformed for upload into programs such as EcoStruxure™ Power Monitoring Expert or any compatible software.

Data publishing function supports 4 transfer protocols over Ethernet or Wi-Fi:

- HTTP
- FTP
- HTTPS
- SMTP

Additional functions

Gateway

If selected by the user, the Com'X 210 can also make all data from connected devices available in real-time:

- In Modbus TCP/IP format over Ethernet or Wi-Fi.
- For requests by an energy management software.

Modbus packets can be sent from managing software to field devices through Modbus serial line or Modbus TCP/IP over Ethernet.

Commercial ref. no.	Product description
EBX210	Com'X 210 data logger 24 V DC or 230 V AC power supplied
EBXA-USB-Wi-Fi	Com'X Wi-Fi USB interface
EBXA-GPRS	Com'X GPRS interface
EBXA-ANT-5M	Com'X External GPRS antenna

Com'X 510

A highly flexible plug-and-play Energy Server Com'X 510 collects and stores WAGES consumptions and environmental parameters such as temperatures, humidity and CO₂ levels in a building. The Com'X 510 has up to 2 year data storage and embedded webpages which means all your energy data can be viewed and managed on-site.

Applications

- All-in-one-box energy management solution especially suitable for buildings up to 10,000 sq. metres

PB114582

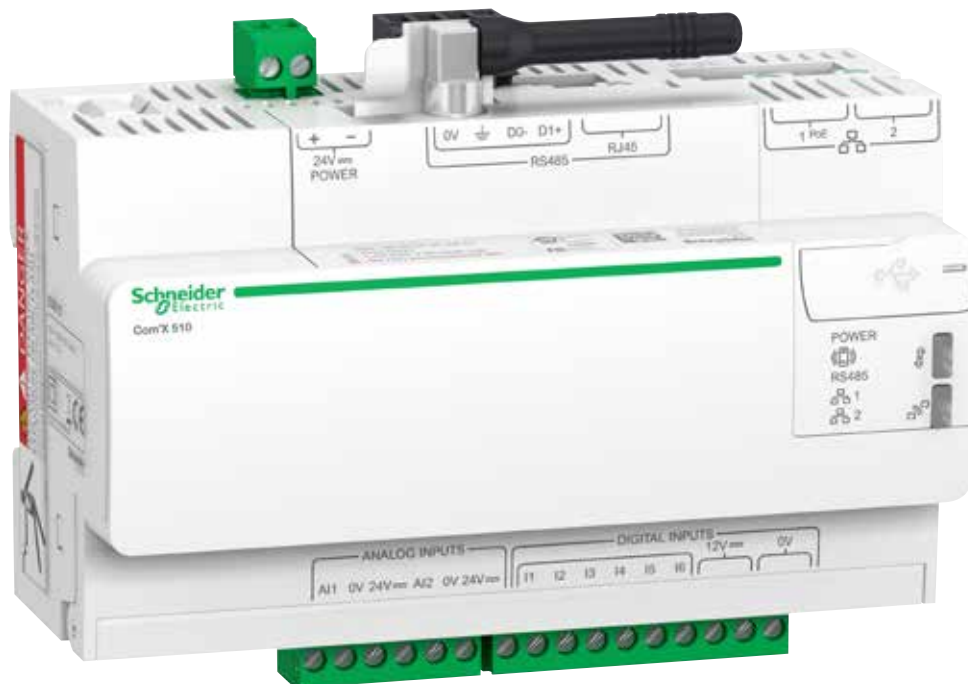

EBX510

The solution for

All markets that can benefit from a solution that includes data logger Com'X 510:

- Buildings
- Industry

Benefits

- Data collection from up to 64 field devices
- Data publishing leveraging existing infrastructures : Ethernet or Wi-Fi, GPRS-ready
- Quick fitting into electrical switchboards thanks to DIN rail clipping and profile.
- Quick setup and configuration thanks to intuitive HMI

Competitive advantages

- Fit any PDU or RPP design for both new and retrofit projects
- Class 1.0 system accuracy
- Ethernet communication

Energy management solution

The data collected and stored by Com'X 510 can be processed and displayed through its own onboard webpage.

The Com'X 510 also provides a transparent interface between Ethernet-based networks and field devices. This gateway function supports the use of monitoring software, such as EcoStruxure™ Power Monitoring Expert for data collection, trending, event management, analysis and further processing.

Conformity of standards

- EN 60950

Architecture

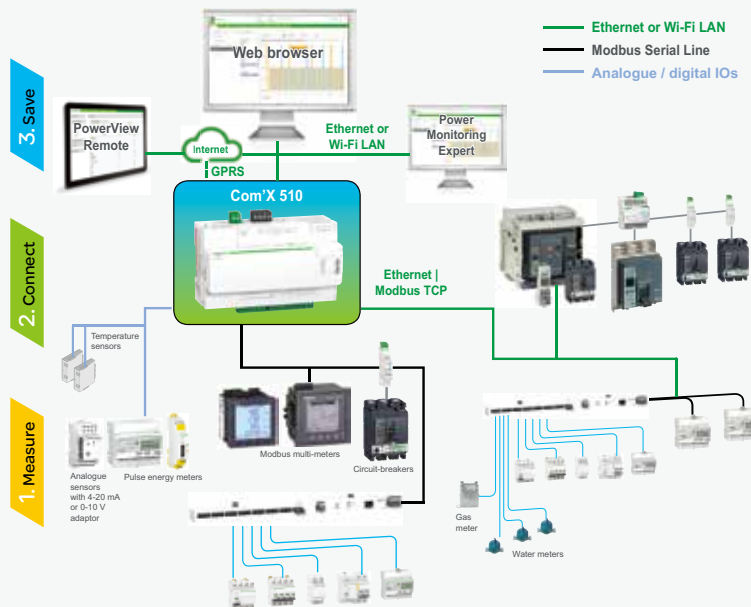

FB114856

Com'X 510 Energy server



Energy dashboard comparing accumulated over time energy values (partial screen)

Data collector

As soon as the data logger is connected to the LAN, it can be detected and assigned an IP address by DHCP. Your operating system's DPWS feature allows your computer to automatically recognise the device as Com'X. Embedded web pages are then immediately accessible by clicking each Com'X device icon or by typing the assigned IP address into your web browser.

Collects and stores energy data from up to 64 field devices, connected to either:

- Ethernet TCP/IP field network.
- Modbus Serial line network (up to 32 devices).
- Embedded digital and analogue inputs.

"Field devices" consist of:

- PowerLogic meters for power and energy monitoring.
- Masterpact, Powerpact, or Compact circuit-breakers for protection and monitoring.
- Acti9 protection devices, meters, remote controlled switches, etc.
- Water, Air, Gas, Electricity, and Steam (WAGES) consumption meters, from specialised manufacturers, delivering pulses as per standard (see table at end of this document).
- Environmental sensors such as temperatures, humidity, and CO₂ levels in a building, providing analogue information.

Data logging and storage capabilities include:

- Data logging period: configurable from every minute to once a week.
- Data storage duration: up to 2 years, depending on quantity of collected data.
- Able to set time and send reset instructions to field devices.

Embedded energy management software

The Com'X provides the end-user with immediate visibility into energy consumption throughout the site. As soon as the Com'X is connected to the Local Area Network (LAN), several web pages are accessible via any standard web browser, (without plug-in or additional components).

These web pages display real-time data as it is collected, in easy to understand tabular and summary formats. In addition, users can get simple analysis of historical data in bar graph or trending formats.

Com'X 510 Energy server



Energy Server Com'X 510 data logger

Additional functions

Data publisher

Batches of collected data can also be periodically transmitted to an Internet server, as:

- XML files, for processing by EcoStruxure™ Power Management software products
- CSV files for viewing in Excel or transformed for uploading to programs such as EcoStruxure™ Power Monitoring Expert or any compatible software

Data publishing function supports 4 transfer protocols over Ethernet or Wi-Fi:

- HTTP
- HTTPS
- FTP
- SMTP

Gateway

- If selected by the user, the Com'X 510 can make data from connected devices available in real time
- In Modbus TCP/IP format over Ethernet or Wi-Fi
- For requests by energy management software

Modbus packets can be sent from managing software to field devices through Modbus serial line or Modbus TCP/IP over Ethernet.



Raw data and measurements from one field device (partial screen)



Historical trending comparing multiple devices or multiple topics (partial screen)

Commercial reference numbers	Description
EBX510	Com'X 510 energy server 24 V DC power supplied UL rated
EBXA-USB-WiFi	Com'X Wi-Fi USB interface
EBXA-GPRS	Com'X GPRS interface
EBXA-ANT-5M	Com'X External GPRS antenna
EBXA-USB-Zigbee	Com'X Zigbee USB interface

Com'X 210/510 Data Logger



Connection points

- | | |
|------------------|--------------------|
| 1 Terminal block | 3 Ethernet port #1 |
| 2 RJ45 cable | 4 Ethernet port #2 |



Power supply to analogue and digital inputs



Wi-Fi USB stick



GPRS modem



GPRS antenna

Connectivity

- Modbus SL / RS-485 connections to field devices
 - By cable with RJ45 connector.
- 2 Ethernet ports
 - Used to either separate upstream connection from field devices network or to daisy chain Ethernet devices.
 - RJ45 10/100BASE connectors.
 - Static IP address.
- Ethernet port #1
 - Connection to Local Area Network (LAN).
 - PoE Class 3 (802.3af) can act as main/backup power supply for the Com'X.
 - DHCP client.
- Ethernet port # 2
 - Connection to field devices.
 - DHCP client or server.
- Power supply to analogue and digital outputs
 - Outputs to supply sensors and inputs when Com'X is supplied through 24 V DC input on top:
 - 12 V DC 60 mA for digital inputs.
 - 24 V DC for analogue inputs.
 - Compliant with electrical switchboard environment (temperature, electromagnetic compatibility).
- 2 inputs for analogue sensors
 - PT100 or PT1000 temperature probes.
 - Various sensors (humidity, CO₂, etc.) with 0-10 V output.
 - Various sensors with 4-20 mA output
- 6 inputs for dry contact sensors or pulse counters
 - Max 25 pulses per second (min duration 20 ms)
 - IEC 62053-31 Class A
- Wi-Fi USB stick
 - As an alternative to publication over Ethernet, connects Com'X to the site Wi-Fi router for regular data transmission.
 - Can also be used for Com'X 510 configuration through one-to-one connection with laptop or tablet.
 - Simply plugs into USB port 2 under front cover.
- GPRS modem
 - For connection to the data processing server through cellular or user's APN network.
 - Also connect to Schneider Electric's Digital Service Platform.
 - Especially suitable for sites with no internet access.
 - Simply plugs into dedicated port under the front cover.
- GPRS antenna
 - Improves GPRS signal strength in case of poor transmission conditions.
 - Recommended for Com'X located inside metallic electrical panels.

Com'X 210/510 setup and configuration

Setup and configuration

Connection to LAN

As soon as they are connected to the LAN, Com'X devices can be detected and assigned an IP address by DHCP. Your operating system's DPWS feature allows your computer to automatically recognise the device as Com'X. Embedded web pages are then immediately accessible by clicking each Com'X device icon or by typing the assigned IP address into your web browser.

Field device auto-discovery

The user-activated device discovery function automatically identifies all field devices connected to Modbus SL, Ethernet port.

- Schneider Electric devices display with the product image.
- Other devices appear as "unknown," allowing the user to manually assign a device type.
- User can assign their own device types.
- Users can complete additional device identification fields, such as circuit ID or building zone.

Data selection for logging and publication

Web page configuration tabs allow you to configure, in just a few clicks, which connected field devices collect and publish data.

- Advanced diagnostics and troubleshooting features
- Modbus serial and TCP/IP device statistics.
- Ethernet network statistics.
- Communications check wizard.
- Direct reading of register values from local and remote devices.

Additional features and benefits

- Cybersecurity - works well with your cyber security architecture.
- 2 Ethernet ports to separate upstream cloud connection, or to daisy chain with other Ethernet devices, from field device network.
- Data storage in case of communications failure.
- Local backup of configuration parameters - back up your system to a USB storage device and have it available for system restore or to duplicate the configuration on another box.



Device settings page (partial), as displayed after auto-discovery, enabling user to assign circuit identifications and select data for logging and publication.

Com'X 210/510 installation

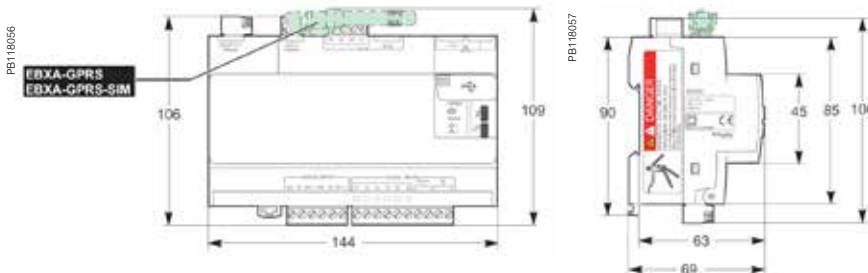

DIN rail fitting (Front face IP40, terminals IP20).

Com'X 210/510 Data Logger

Technical specifications			
Com'X 210/510 Environment			
Operating temperature	-25° to 60°C Com'X 210 -25° to 70°C Com'X 510		
Storage temperature	-40° to 85°C		
GPRS dongle Operating temperature	-20° to 60°C		
GPRS dongle Storage temperature	-40° to 85°C		
Wif-Fi dongle Operating temperature	0° to 50°C		
Wi-Fi dongle Storage temperature	-20° to 80°C		
Humidity	5 to 95 % relative humidity (without condensation) at 55°C		
Pollution	Class III		
Safety standards / regulation			
International (CB scheme)	IEC 60950		
USA	UL 508		
USA	UL 60950 (Com'X 510 only)		
Canada	cUL 60950 (Com'X 510 only)		
Canada	cULus 508		
Europe	EN 60950		
Quality Brands			
	CE, UL		
Power Supply		Com'X 210	Com'X 510
AC	100-230 V (+/- 15%)(50-60 Hz)	■	
DC	24 V (+/- 10%)	■	■
Power over Ethernet	15.4 W DC	■	■
Max power	26 W max	■	■
Mechanical		Com'X 210	Com'X 510
IP	Front face IP40, terminals IP20	■	■
Dimensions (HxWxD)	91 x 144 x 65.8 mm	■	■
Weight	450 g	■	■

Commercial reference numbers

Commercial ref. no.	Description	Page	Commercial ref. no.	Description	Page
	Current Transformers	15	METSECT5DE100	CT tropicalised 1000 5 dual out. bars 54x102	
	CT Ip/5 A ratio	16	METSECT5DE125	CT tropicalised 1250 5 dual out. bars 54x102	
16550	44 x 66 x 37 Adapter for DIN rails Mounting plate		METSECT5DE150	CT tropicalised 1500 5 dual out. bars 54x102	
16551	56 x 84 x 60 Adapter for DIN rails Mounting plate, insulated locking screw		METSECT5DE200	CT tropicalised 2000 5 dual out. bars 54x102	
16552	56 x 84 x 60 Adapter for DIN rails Mounting plate Insulated locking screw sealable cover		METSECT5DH125	CT tropicalised 1250 5 dual out. bars 38x102	
16553	77 x 107 x 64 Adapter for DIN rails Mounting plate Insulated locking screw		METSECT5DH150	CT tropicalised 1500 5 dual out. bars 38x102	
METSECT5CC004	CC 40 A		METSECT5DH200	CT tropicalised 2000 5 dual out. bars 38x102	
METSECT5CC005	CC 50 A			Rogowski CTs	25
METSECT5CC006	CC 60 A		METSECTR25500	Rogowski CT, 250 mm core length, 80 mm dia.	
METSECT5CC008	CC 75 A		METSECTR30500	Rogowski CT, 250 mm core length, 96 mm dia.	
METSECT5CC010	CC 100 A		METSECTR46500	Rogowski CT, 250 mm core length, 146 mm dia.	
METSECT5CC013	CC 125 A		METSECTR60500	Rogowski CT, 250 mm core length, 191 mm dia.	
METSECT5CC015	CC 150 A		METSECTR90500	Rogowski CT, 250 mm core length, 287 mm dia.	
METSECT5CC020	CC 200 A			0.333 V 3-in-1 CTs with RJ45 for PM53xR	
METSECT5CC025	CC 250 A		METSECTV25006	LVCT SolidC 3in1 RJ45 25mmCtr 60A:1/3V	
METSECT5MB025	MB 250 A		METSECTV25010	LVCT SolidC 3in1 RJ45 25mmCtr 100A:1/3V	
METSECT5MB030	MB 300 A		METSECTV25013	LVCT SolidC 3in1 RJ45 25mmCtr 125A:1/3V	
METSECT5MB040	MB 400 A		METSECTV25016	LVCT SolidC 3in1 RJ45 25mmCtr 160A:1/3V	
METSECT5MA015	MA 150 A		METSECTV35006	LVCT SolidC 3in1 RJ45 35mmCtr 60A:1/3V	
METSECT5MA020	MA 200 A		METSECTV35010	LVCT SolidC 3in1 RJ45 35mmCtr 100A:1/3V	
METSECT5MA025	MA 250 A		METSECTV35012	LVCT SolidC 3in1 RJ45 35mmCtr 120A:1/3V	
METSECT5MA030	MA 300 A		METSECTV35013	LVCT SolidC 3in1 RJ45 35mmCtr 125A:1/3V	
METSECT5MA040	MA 400 A		METSECTV35015	LVCT SolidC 3in1 RJ45 35mmCtr 150A:1/3V	
METSECT5MC025	MC 250 A		METSECTV35016	LVCT SolidC 3in1 RJ45 35mmCtr 160A:1/3V	
METSECT5MC030	MC 300 A		METSECTV35020	LVCT SolidC 3in1 RJ45 35mmCtr 200A:1/3V	
METSECT5MC040	MC 400 A		METSECTV35025	LVCT SolidC 3in1 RJ45 35mmCtr 250A:1/3V	
METSECT5MC050	MC 500 A		METSECTV45025	LVCT SolidC 3in1 RJ45 45mmCtr 250A:1/3V	
METSECT5MC060	MC 600 A		METSECTV45030	LVCT SolidC 3in1 RJ45 45mmCtr 300A:1/3V	
METSECT5MC080	MC 800 A		METSECTV45040	LVCT SolidC 3in1 RJ45 45mmCtr 400A:1/3V	
METSECT5MD050	MD 500 A		METSECTV45050	LVCT SolidC 3in1 RJ45 45mmCtr 500A:1/3V	
METSECT5MD060	MD 600 A		METSECTV45060	LVCT SolidC 3in1 RJ45 45mmCtr 600A:1/3V	
METSECT5MD080	MD 800 A		METSECTV45063	LVCT SolidC 3in1 RJ45 45mmCtr 630A:1/3V	
METSECT5CYL1	Cylinder 8.5 mm dia.		METSECTV29006	LVCT SolidC 3in1 RJ45 29mmCtr 60A:1/3V	
METSECT5CYL2	Cylinder 10.5 mm dia.		METSECTV29010	LVCT SolidC 3in1 RJ45 29mmCtr 100A:1/3V	
METSECT5COVER	sealable cover 60.5 x 22 x 23.5 mm for CT TI		METSECTV29012	LVCT SolidC 3in1 RJ45 29mmCtr 120A:1/3V	
METSECT5VV500	CT tropicalised 5000 5 bars 55x165		METSECTV29013	LVCT SolidC 3in1 RJ45 29mmCtr 125A:1/3V	
METSECT5VV600	CT tropicalised 6000 5 bars 55x165		METSECTV29015	LVCT SolidC 3in1 RJ45 29mmCtr 150A:1/3V	
METSECT5DA040	CT tropicalised 400 5 dual out. bars 32x65		METSECTV29016	LVCT SolidC 3in1 RJ45 29mmCtr 160A:1/3V	
METSECT5DA050	CT tropicalised 500 5 dual out. bars 32x65		METSECTV29020	LVCT SolidC 3in1 RJ45 29mmCtr 200A:1/3V	
METSECT5DA060	CT tropicalised 600 5 dual out. bars 32x65		METSECTV70080	LVCT SolidC 3in1 RJ45 70mmCtr 800A:1/3V	
METSECT5DA080	CT tropicalised 800 5 dual out. bars 32x65		METSECTV70100	LVCT SolidC 3in1 RJ45 70mmCtr 1000A:1/3V	
METSECT5DA100	CT tropicalised 1000 5 dual out. bars 32x65		METSECTV70125	LVCT SolidC 3in1 RJ45 70mmCtr 1250A:1/3V	
METSECT5DA125	CT tropicalised 1250 5 dual out. bars 32x65		METSECTV70160	LVCT SolidC 3in1 RJ45 70mmCtr 1600A:1/3V	
METSECT5DA150	CT tropicalised 1500 5 dual out. bars 32x65			Panel Instruments	26
METSECT5DB100	CT tropicalised 1000 5 dual out. bars 38x127			DIN rail analogue ammeters, voltmeters	27
METSECT5DB125	CT tropicalised 1250 5 dual out. bars 38x127		16029	0-30 A no 8	
METSECT5DB150	CT tropicalised 1500 5 dual out. bars 38x127		16030	X/5 8	
METSECT5DB200	CT tropicalised 2000 5 dual out. bars 38x127		16031	0-5 A	
METSECT5DB250	CT tropicalised 2500 5 dual out. bars 38x127		16032	0-50 A 50/5	
METSECT5DB300	CT tropicalised 3000 5 dual out. bars 38x127		16033	0-75 A 75/5	
METSECT5DC200	CT tropicalised 2000 5 dual out. bars 52x127		16034	0-100 A 100/5	
METSECT5DC250	CT tropicalised 2500 5 dual out. bars 52x127		16035	0-150 A 150/5	
METSECT5DC300	CT tropicalised 3000 5 dual out. bars 52x127		16036	0-200 A 200/5	
METSECT5DC400	CT tropicalised 4000 5 dual out. bars 52x127				
METSECT5DD100	CT tropicalised 1000 5 dual out. bars 34x84				
METSECT5DD125	CT tropicalised 1250 5 dual out. bars 34x84				
METSECT5DD150	CT tropicalised 1500 5 dual out. bars 34x84				

Commercial ref. no.	Description	Page	Commercial ref. no.	Description	Page
16037	0-250 A 250/5		15607	CH "48 x 48" 24 V AC \pm 10 %/50 Hz	
16038	0-300 A 300/5		15608	CH "48 x 48" 230 V AC \pm 10 %/50 Hz	
16039	0-400 A 400/5		15609	CH "48 x 48" 12 to 36 V DC	
16040	0-500 A 500/5			iCI impulse counter	
16041	0-600 A 600/5		15443	iCI 4mm impulse counter DIN	
16042	0-800 A 800/5			Basic Energy Metering	37
16043	0-1000 A 1000/5			iEM2000	38
16044	0-1500 A 1500/5		A9MEM2000T	iEM2000T basic energy meter, no display	
16045	0-2000 A 2000/5		A9MEM2000	iEM2000 basic energy meter	
16060	0-300 V 8		A9MEM2010	iEM2010 energy meter, kWh pulse output	
16061	0-500 V 8		A9MEM2100	iEM2100 basic energy meter	
	DIN rail digital ammeters, voltmeter, freq meter	28	A9MEM2105	iEM2105 energy meter, kWh pulse output with partial meter	
15202	Direct reading iAMP 0-10 A No 4		A9MEM2110	iEM2110 energy meter, kWh and kvarh pulse outputs with two tariffs, four quadrant energy measurement, MID certified	
15209	Multi-rating iAMP 0-5000 A As per rating 4		A9MEM2135	iEM2135 energy meter, M-Bus communication, four quadrant energy measurement, two tariffs, MID certified	
15201	iVLT 0-600 V 4		A9MEM2150	iEM2150 energy meter, Modbus communication, four quadrant energy measurement	
15208	iFRE 20-100 Hz 4		A9MEM2155	iEM2155 energy meter, Modbus communication, four quadrant energy measurement, two tariffs, MID certified	
	72x72 analogue ammeter, voltmeter	29		iEM3000	42
16003	AMP for motor feeder		A9MEM3100	iEM3100 basic energy meter	
16004	AMP for standard feeder X/5		A9MEM3110	iEM3110 energy meter with pulse output	
16009	AMP for standard feeder 0-50 A 50/5		A9MEM3115	iEM3115 multi-tariff energy meter	
16010	AMP for standard feeder 0-100 A 100/5		A9MEM3135	iEM3135 advanced multi-tariff energy meter & electrical parameter plus M-Bus comm port	
16011	AMP for standard feeder 0-200 A 200/5		A9MEM3150	iEM3150 energy meter & electrical parameter plus Modbus RS-485 comm port	
16012	AMP for standard feeder 0-400 A 400/5		A9MEM3155	iEM3155 advanced multi-tariff energy meter & electrical parameter plus Modbus RS-485 comm port	
16013	AMP for standard feeder 0-600 A 600/5		A9MEM3165	iEM3165 advanced multi-tariff energy meter & electrical parameter plus BACnet MS/TP comm port	
16014	AMP for standard feeder 0-1000 A 1000/5		A9MEM3175	iEM3175 advanced multi-tariff energy meter & electrical parameter plus LON TP/FT-10 comm port	
16015	AMP for standard feeder 0-1250 A 1250/5		A9MEM3200	iEM3200 basic energy meter	
16016	AMP for standard feeder 0-1500 A 1500/5		A9MEM3210	iEM3210 energy meter with pulse output	
16019	AMP for standard feeder 0-2000 A 2000/5		A9MEM3215	iEM3215 multi-tariff energy meter	
16003	AMP for motor feeder X/5		A9MEM3235	iEM3235 advanced multi-tariff energy meter & electrical parameter plus M-Bus comm port	
16006	AMP for motor feeder 0-30-90 A 30/5		A9MEM3250	iEM3250 energy meter & electrical parameter plus Modbus RS-485 comm port	
16007	AMP for motor feeder 0-75-225 A 75/5		A9MEM3255	iEM3255 advanced multi-tariff energy meter & electrical parameter plus Modbus RS485 comm port	
16008	AMP for motor feeder 0-200-600 A 200/5		A9MEM3265	iEM3265 advanced multi-tariff energy meter & electrical parameter plus BACnet MS/TP comm port	
16005	VLT 0-500 V		A9MEM3275	iEM3275 advanced multi-tariff energy meter & electrical parameter plus LON TP/FT-10 comm port	
	96x96 analogue ammeter, voltmeter	30	A9MEM3300	iEM3300 basic energy meter	
16074	AMP for standard feeder X/5		A9MEM3310	iEM3310 energy meter with pulse output	
16079	AMP for standard feeder 0-50 A 50/5		A9MEM3335	iEM3335 advanced multi-tariff energy meter & electrical parameter plus M-Bus comm port	
16080	AMP for standard feeder 0-100 A 100/5		A9MEM3350	iEM3350 energy meter & electrical parameter plus Modbus RS-485 comm port	
16081	AMP for standard feeder 0-200 A 200/5		A9MEM3355	iEM3355 advanced multi-tariff energy meter & electrical parameter plus Modbus RS485 comm port	
16082	AMP for standard feeder 0-400 A 400/5		A9MEM3365	iEM3365 advanced multi-tariff energy meter & electrical parameter plus BACnet MS/TP comm port	
16083	AMP for standard feeder 0-600 A 600/5				
16084	AMP for standard feeder 0-1000 A 1000/5				
16085	AMP for standard feeder 0-1250 A 1250/5				
16086	AMP for standard feeder 0-1500 A 1500/5				
16087	AMP for standard feeder 0-2000 A 2000/5				
16088	AMP for standard feeder 0-2500 A 2500/5				
16089	AMP for standard feeder 0-3000 A 3000/5				
16090	AMP for standard feeder 0-4000 A 4000/5				
16091	AMP for standard feeder 0-5000 A 5000/5				
16092	AMP for standard feeder 0-6000 A 6000/5				
16073	AMP for motor feeder X/5				
16076	AMP for motor feeder 0-30-90 A 30/5				
16077	AMP for motor feeder 0-75-225 A 75/5				
16078	AMP for motor feeder 0-200-600 A 200/5				
16075	VLT 0-500 V				
	48x48 CMA, CMV selector switches	31			
16017	CMA 20 4				
16018	CMV 500 7				
	DIN rail iCMA, iCMV selector switches	32			
15126	iCMA 10 415 4				
15125	iCMV 10 415 4				
	iCH hour counter	33			
15440	iCH "DIN" 230 V AC \pm 10 %/50 Hz 4mm				

Commercial ref. no.	Description	Page	Commercial ref. no.	Description	Page
A9MEM3375	iEM3375 advanced multi-tariff energy meter & electrical parameter plus LON TP/FT-10 comm port		METSEPM5331	Power Meter range 72 mm depth, control power to 415 V AC, CI 0.5S, 31st harmonic, 256 kB, RS-485 Modbus, 2DI/2DO, 2Relay, MID cert	
A9MEM3455	iEM3455 advanced multi-tariff energy meter & electrical parameter plus Modbus RS-485 comm port		METSEPM5340	Power Meter range 72 mm depth, control power to 415 V AC, CI 0.5S, 31st harmonic, 256 kB, Ethernet, 2DI/2DO, 2Relay	
A9MEM3465	iEM3465 advanced multi-tariff energy meter & electrical parameter plus BACnet MS/TP comm port		METSEPM5341	Power Meter range 72 mm depth, control power to 415 V AC, CI 0.5S, 31st harmonic, 256 kB, Ethernet, 2DI/2DO, 2Relay, MID cert	
A9MEM3555	iEM3555 advanced multi-tariff energy meter & electrical parameter plus Modbus RS-485 comm port		METSEPM5560	Power Meter range 77 mm depth, control power to 480 V AC, CI 0.2S, 63rd harmonic, 1.1 MB, Modbus and Ethernet, 4DI/2DO	
A9MEM3565	iEM3565 advanced multi-tariff energy meter & electrical parameter plus BACnet MS/TP comm port		METSEPM5561	Power Meter range 77 mm depth, control power to 480 V AC, CI 0.2S, 63rd harmonic, 1.1 MB, Modbus and Ethernet, MID cert	
	LVCTs	47	METSEPM5562	Power Meter range 77 mm depth, control power to 480 V AC, CI 0.2S, 63rd harmonic, 1.1 MB, RMICAN approved, HW lockable, 4DI/2DO	
LVCT00050S	CT, split-core, Size 0, 50 A to 0.333 V		METSEPM5562MC	Power Meter range 77 mm depth, control power to 480 V AC, CI 0.2S, 63rd harmonic, 1.1 MB, RMICAN approved, factory sealed, 4DI/2DO	
LVCT00101S	CT, split-core, Size 1, 100 A to 0.333 V		METSEPM5563*	Power Meter range 77 mm depth, control power to 480 V AC, CI 0.2S, 63rd harmonic, 1.1 MB, DIN mount, no display, 4DI/2DO	
LVCT00201S	CT, split-core, Size 1, 200 A to 0.333 V		METSEPM5563RD*	PM5500 power meter, ETH-serial + 4DI-2DO out, remote display	
LVCT00102S	CT, split-core, Size 2, 100 A to 0.333 V		METSEPM5RD*	Remote display for PM5563 power meter	
LVCT00202S	CT, split-core, Size 2, 200 A to 0.333 V		*METSEPM5563RD includes both METSEPM5563 and METSEPM5RD		
LVCT00302S	CT, split-core, Size 2, 300 A to 0.333 V		METSEPM51HK	Hardware kit for PM51XX (voltage, current, comms & IO connectors + moulding clips)	
LVCT00403S	CT, split-core, Size 3, 400 A to 0.333 V		METSEPM53HK	Hardware kit for PM53XX (voltage, current, comms & IO connectors + moulding clips)	
LVCT00603S	CT, split-core, Size 3, 600 A to 0.333 V		METSEPM51_3RSK	Revenue sealing kit for PM51XX & PM53XX (sealing covers for voltage & current connectors)	
LVCT00803S	CT, split-core, Size 3, 800 A to 0.333 V		METSEPM55HK	Hardware kit for PM55XX (voltage, current, comms & IO connectors & moulding clips)	
LVCT00804S	CT, split-core, Size 4, 800 A to 0.333 V		METSEPM55RSK	Revenue sealing kit for PM55XX (sealing covers for voltage & current connectors)	
LVCT01004S	CT, split-core, Size 4, 1000 A to 0.333 V			Cables	
LVCT01204S	CT, split-core, Size 4, 1200 A to 0.333 V		METSEPM5CAB3	Remote Display cable	
LVCT01604S	CT, split-core, Size 4, 1600 A to 0.333 V		DCEPCURJX5GYM	Category 5e, Patch Cord, UTP, 0.5 M, Grey	
LVCT02004S	CT, split-core, Size 4, 2000 A to 0.333 V		DCEPCURJ01GYM	Category 5e, Patch Cord, UTP, 1 M, Grey	
LVCT02404S	CT, split-core, Size 4, 2400 A to 0.333 V		DCEPCURJ02GYM	Category 5e, Patch Cord, UTP, 2 M, Grey	
	Basic Multi-Function Metering	51	DCEPCURJ03GYM	Category 5e, Patch Cord, UTP, 3 M, Grey	
	ION6200	52	DCEPCURJ05GYM	Category 5e, Patch Cord, UTP, 5 M, Grey	
M6200	PowerLogic ION6200 meter		DCEPCURJ10GYM	Category 5e, Patch Cord, UTP, 10 M, Grey	
	PM3000	59		Communications & Gateways	212
METSEPM3200	PM3200 basic power meter			Link150 Ethernet gateway	216
METSEPM3210	PM3210 power meter with pulse output		EGX150	Link150 Ethernet gateway	
METSEPM3250	PM3250 power meter with RS485 port			Com'X 200/210/510	220
METSEPM3255	PM3255 power meter plus 2 digital inputs, 2 digital outputs with RS-485 port		EBX200	Com'X 200 data logger 24 V DC or 230 V AC power supplied	
	PM5350/PM5350IB/PM5350PB/PM5350P	65	EBX210	Com'X 210 data logger 24 V DC power supplied UL rated	
METSEPM5350	PM5350 Power & Energy meter with THD, alarming		EBX510	Com'X 510 energy server 24 V DC power supplied UL rated	
METSEPM5350PB/IB	PM5350PB/IB		EBXA-USB-WiFi	Com'X Wi-Fi USB interface	
METSEPM5350P	PM5350 Power & Energy meter with THD, alarming, multi-tariff and individual harmonics		EBXA-GPRS-SIM	Com'X GPRS interface SIM card	
	PM5000	88	EBXA-GPRS	Com'X GPRS interface	
METSEPM5100	Power Meter range 72 mm depth, control power to 415 V AC, CI 0.5S, 15th harmonic, no communication, 1DO		EBXA-ANT-5M	Com'X External GPRS antenna	
METSEPM5110	Power Meter range 72 mm depth, control power to 415 V AC, CI 0.5S, 15th harmonic, RS-485 Modbus, 1DO		EBXA-USB-Zigbee	Com'X Zigbee USB interface	
METSEPM5111	Power Meter range 72 mm depth, control power to 415 V AC, CI 0.5S, 15th harmonic, RS-485 Modbus, 1DO, MID cert				
METSEPM5310	Power Meter range 72 mm depth, control power to 415 V AC, CI 0.5S, 31st harmonic, 256 kB, RS-485 Modbus, 2DI/2DO				
METSEPM5310R	Power Meter range 72 mm depth, control power to 415 V AC, CI 0.5S, 31st harmonic, 256 kB, RJ45 LVCT, RS-485 Modbus, 2DI/2DO				
METSEPM5320	Power Meter range 72 mm depth, control power to 415 V AC, CI 0.5S, 31st harmonic, 256 kB, Ethernet, 2DI/2DO				
METSEPM5320R	Power Meter range 72 mm depth, control power to 415 V AC, CI 0.5S, 31st harmonic, 256 kB, RJ45 LVCT, Ethernet, 2DI/2DO				
METSEPM5330	Power Meter range 72 mm depth, control power to 415 V AC, CI 0.5S, 31st harmonic, 256 kB, RS-485 Modbus, 2DI/2DO, 2Relay				

Schneider Electric Industries SAS
35, Rue Joseph Monier,
CS 30323
F - 92506 Rueil Malmaison Cedex

RCS Nanterre 954 503 439
Capital social 896 313 776
www.schneider-electric.com

Catalogue for Panel Builders
PLSED310126EN

As standards, specifications and designs develop from time to time, please ask for confirmation of the information given in this document.

Design: Schneider Electric
Photos: Schneider Electric

Over 75 % of Schneider Electric products
have been awarded the Green Premium ecolabel



© 2018 - Schneider Electric - All rights reserved

04-2018

Life Is On

Schneider
Electric